



education™



45821



**SUPER  
POWERED™**

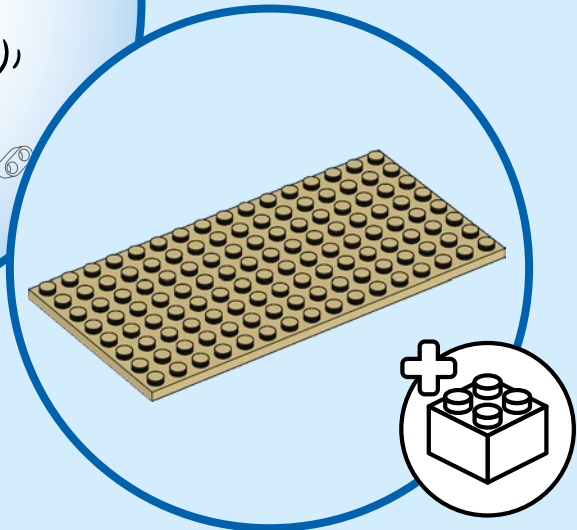
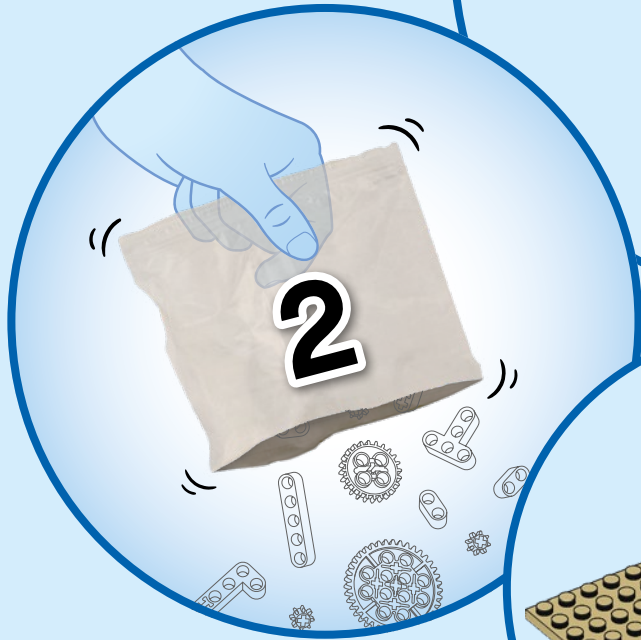
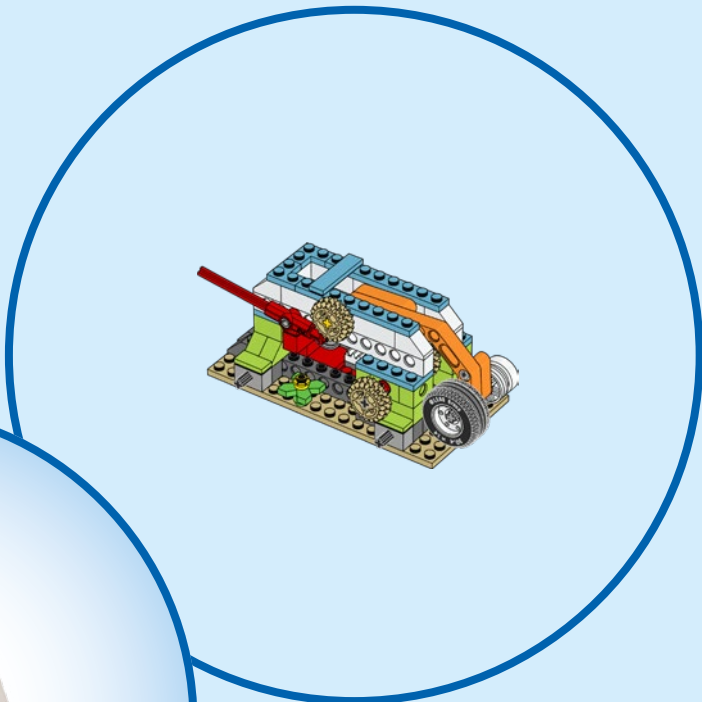

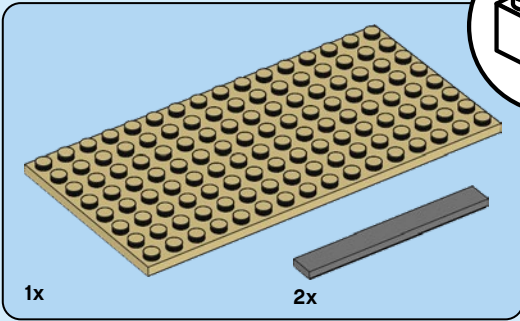
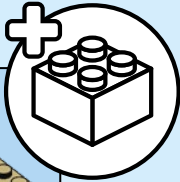
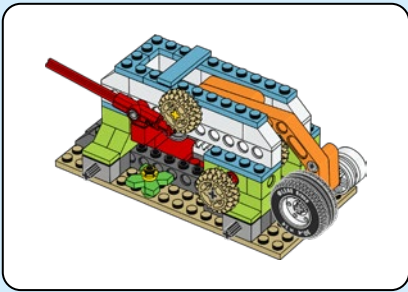

1

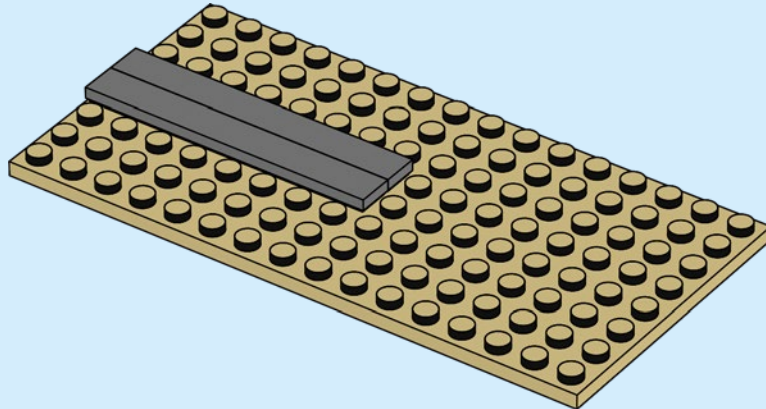

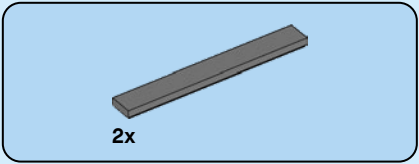

2

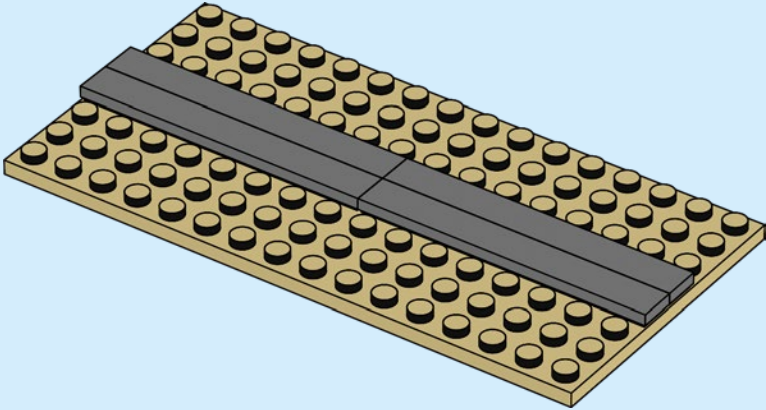

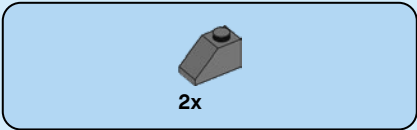

3

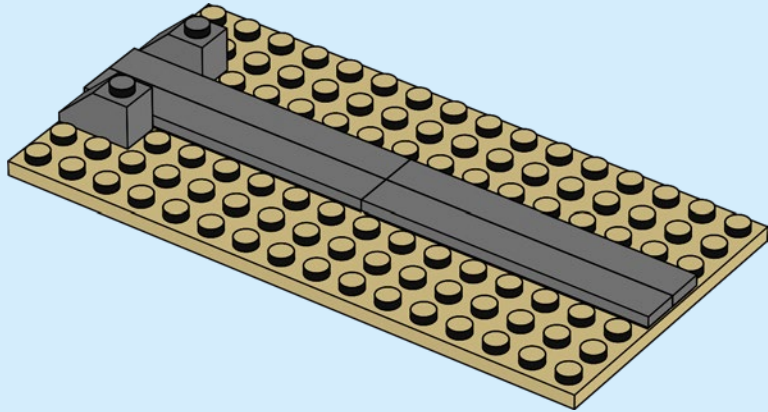

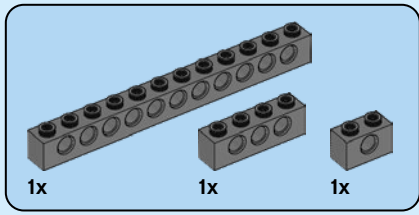

4

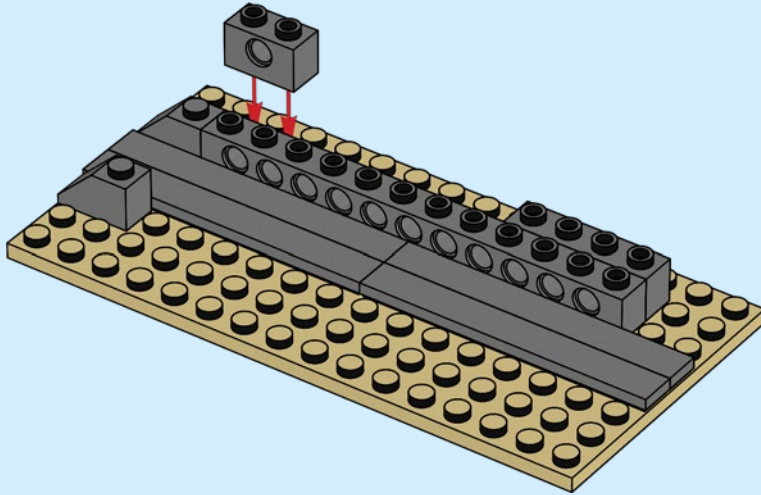

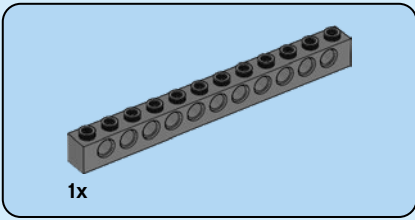

5

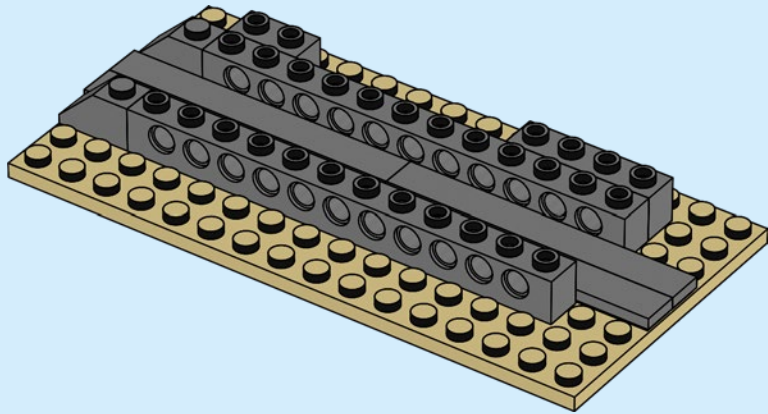

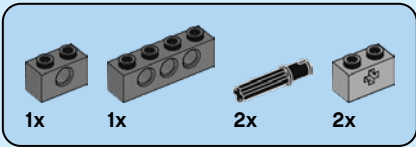

6

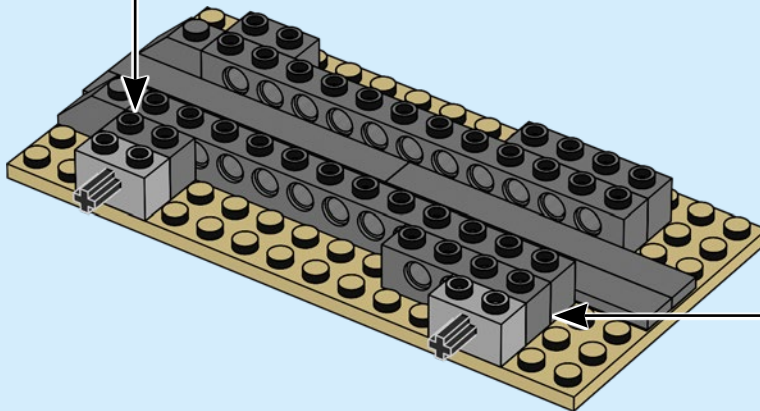
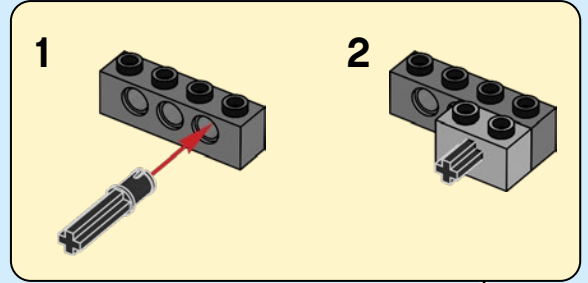
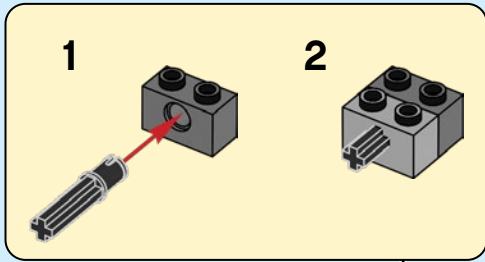



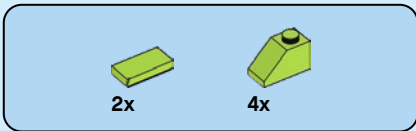

7

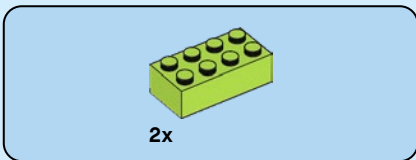
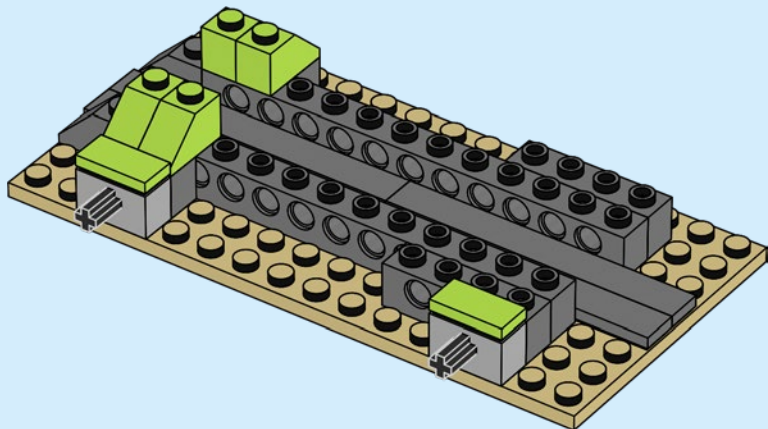

8

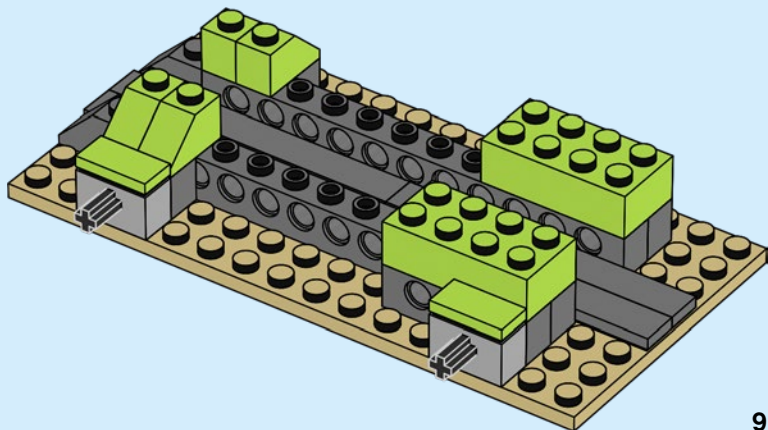



2x

9

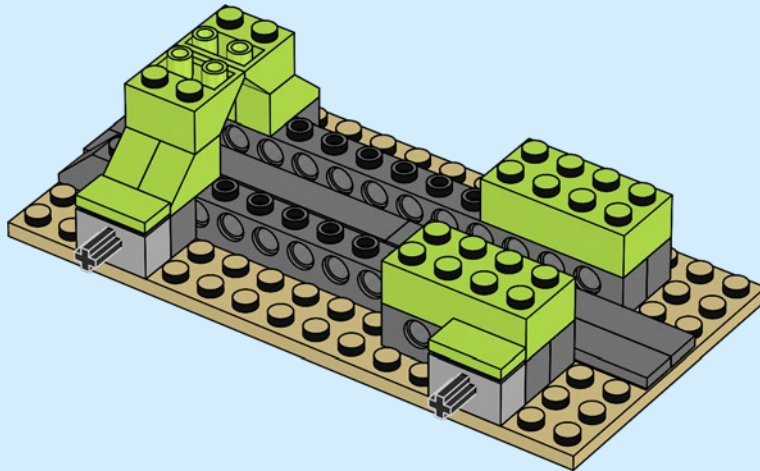



10

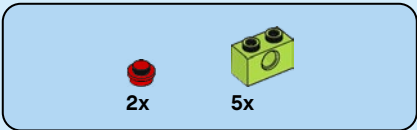
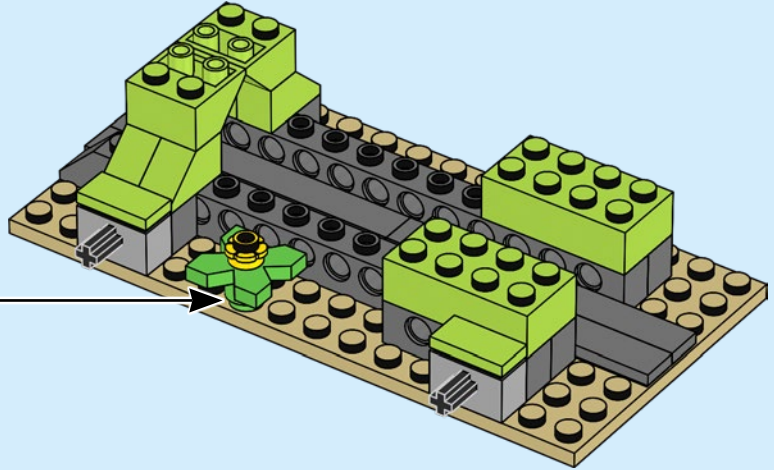
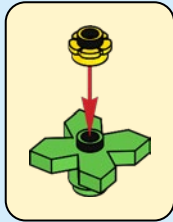

11

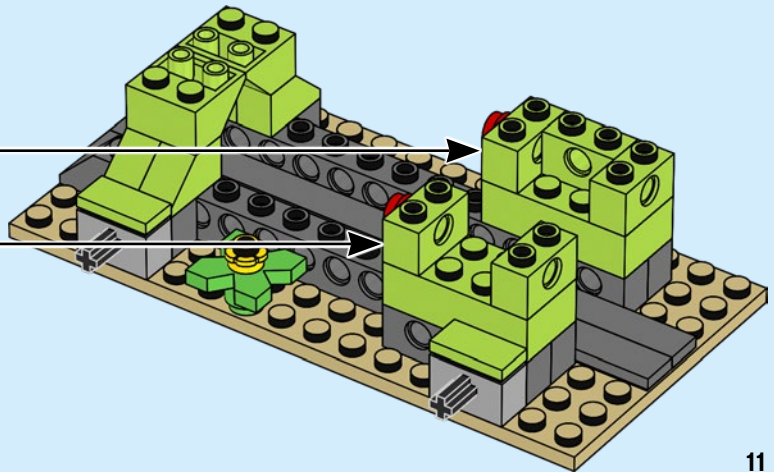
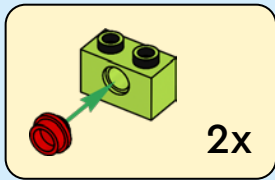

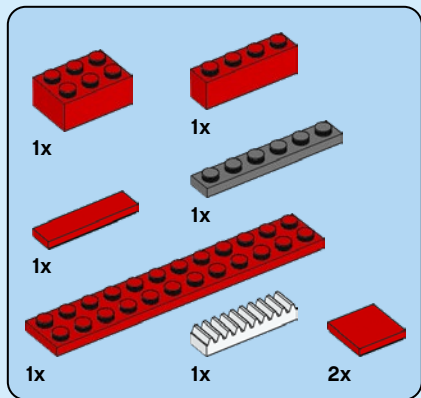

12

1

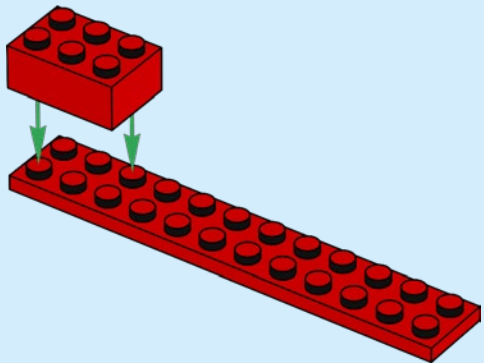

2

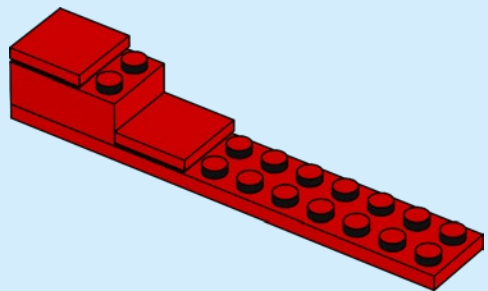

3

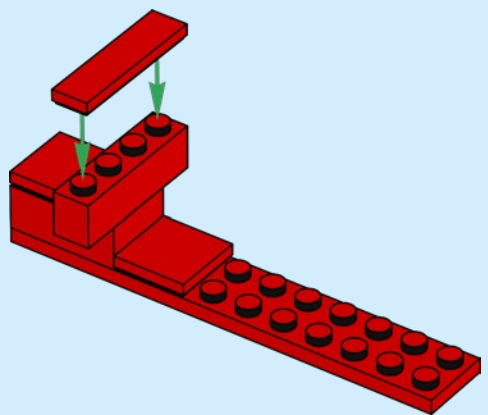

4

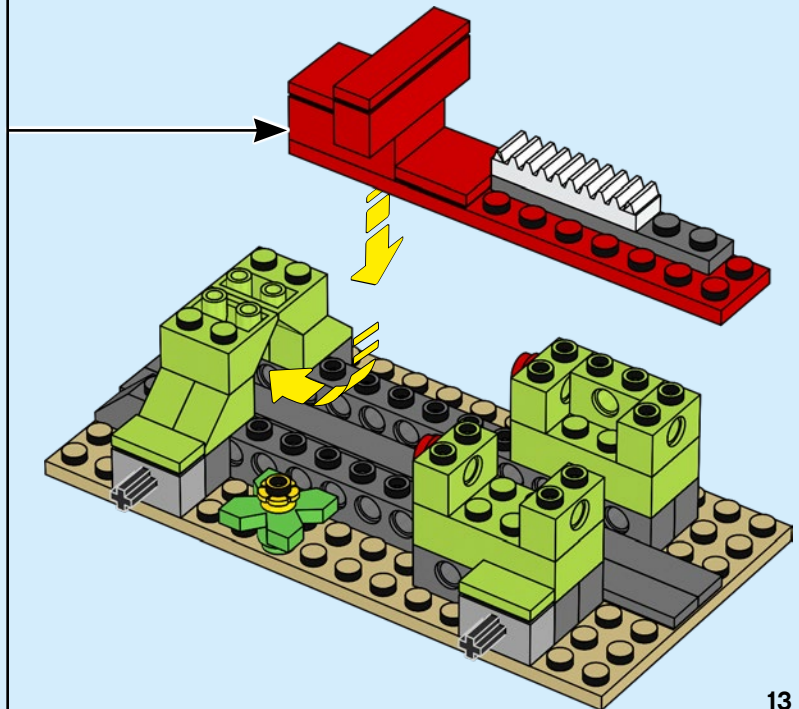
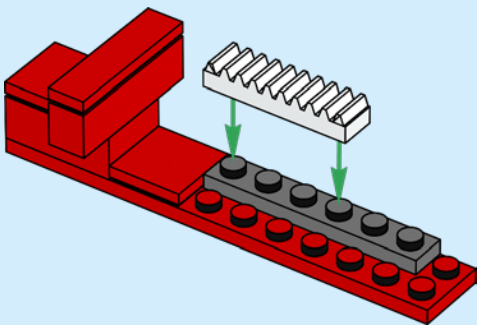

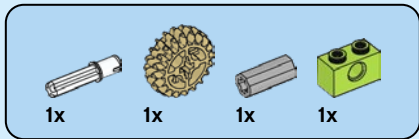

13

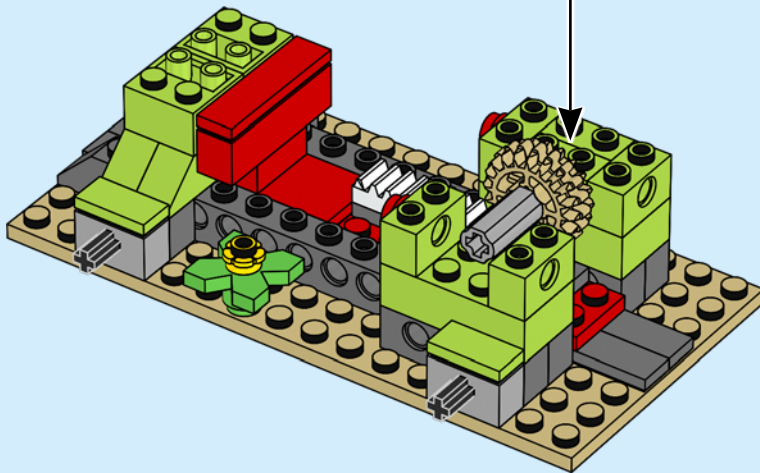
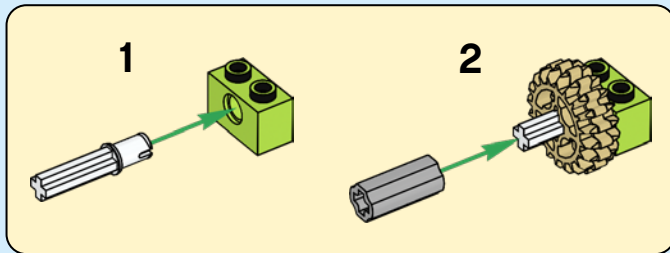



1x

14

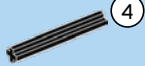
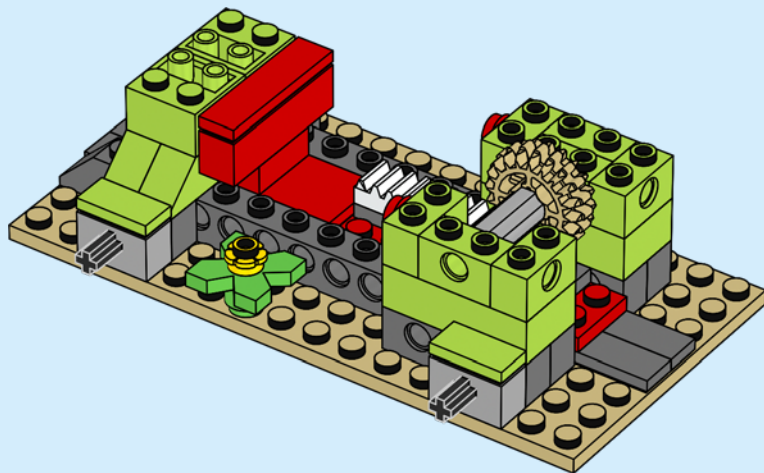

1x



1x



4

1:1

15

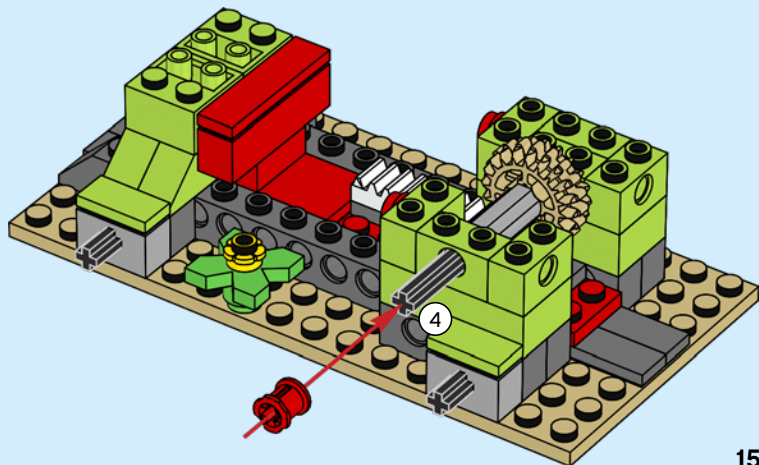





1x

16

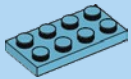
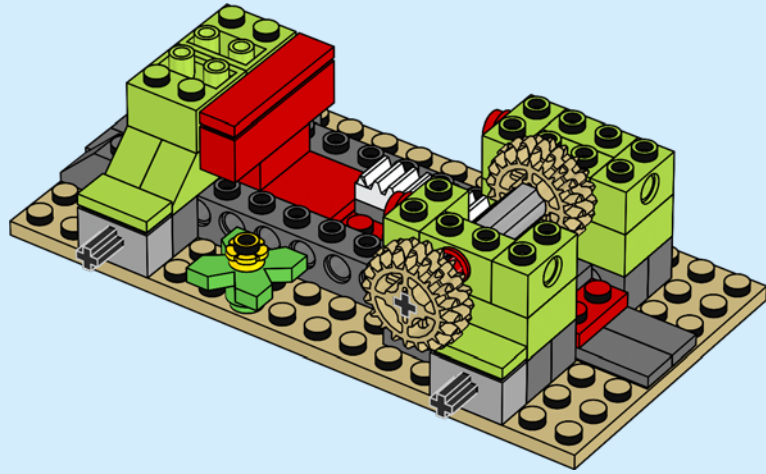

3x

17

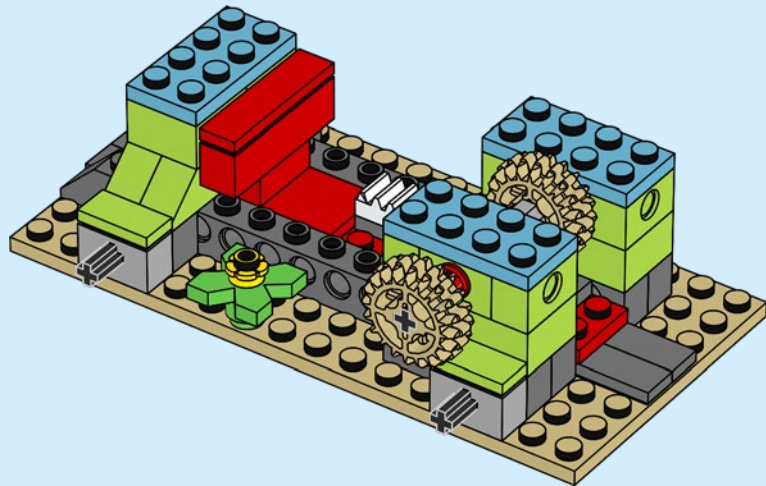



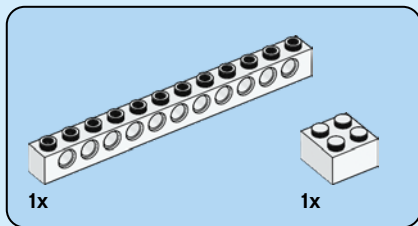

18

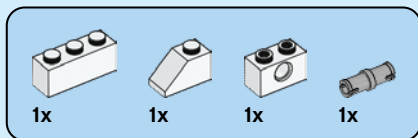
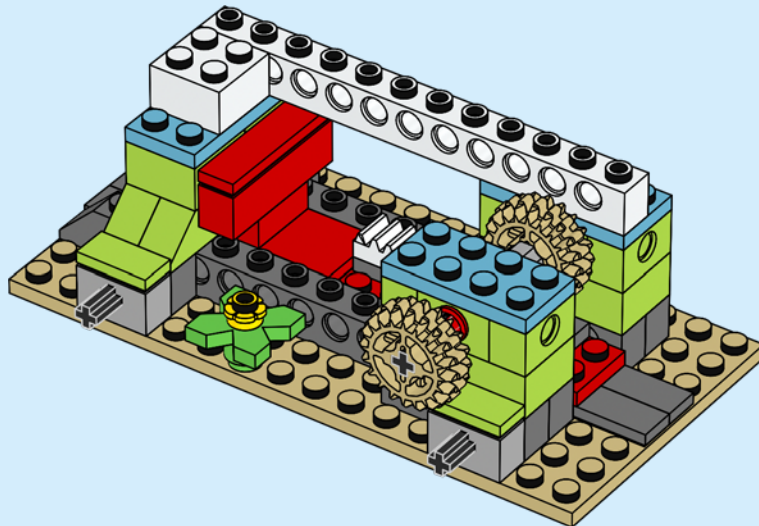

19

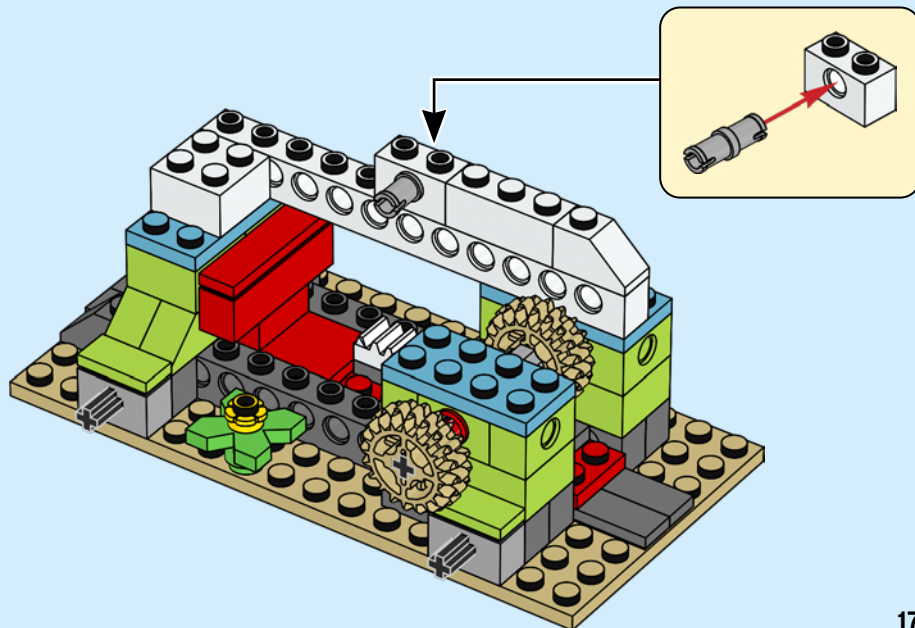

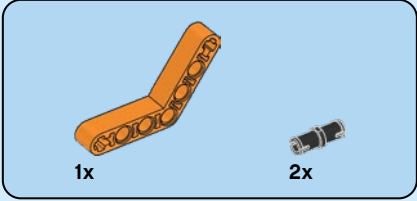
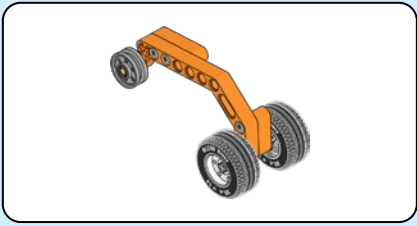

20

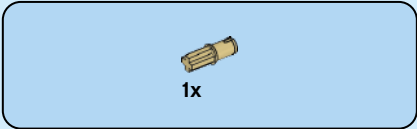
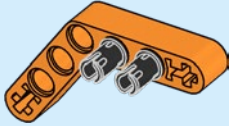

21

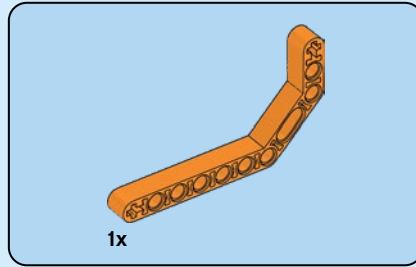
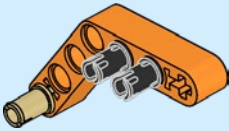

22

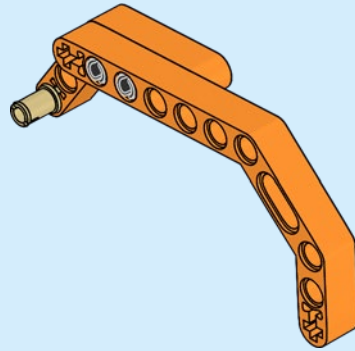



1x

23

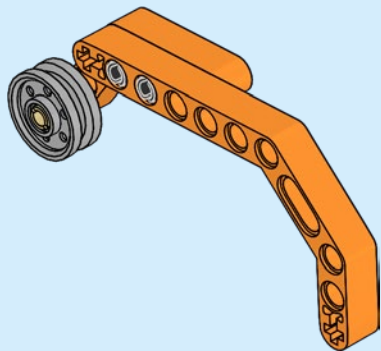

2x

24

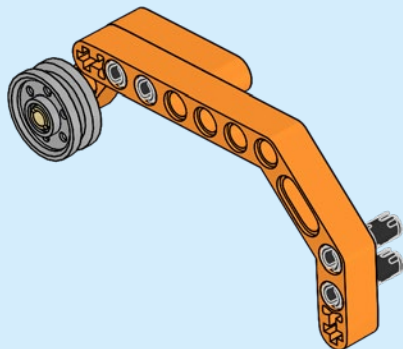

1x

25

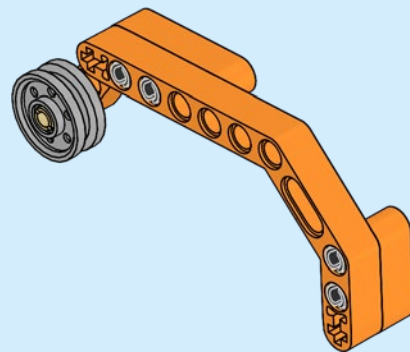

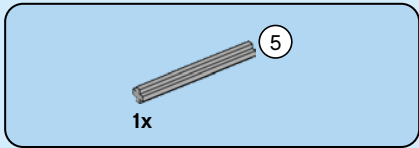

26

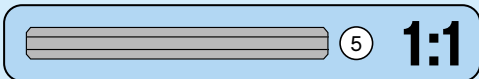
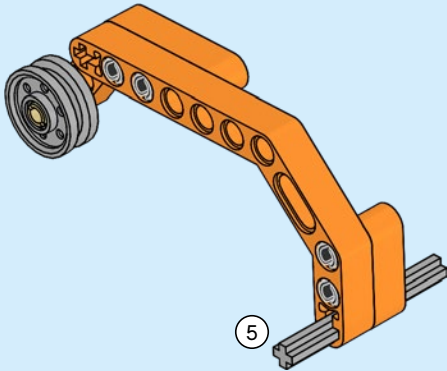

20

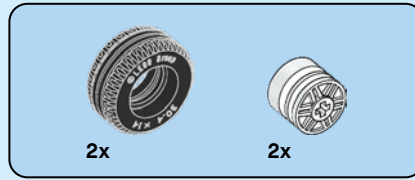

27

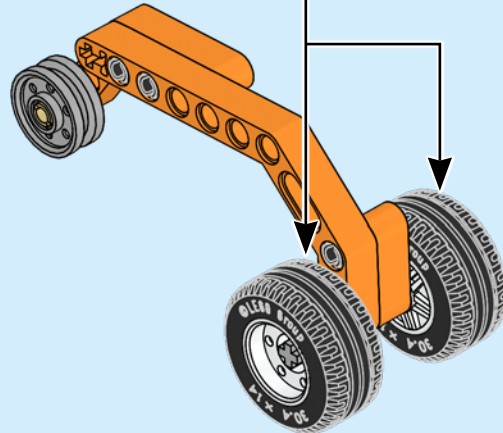
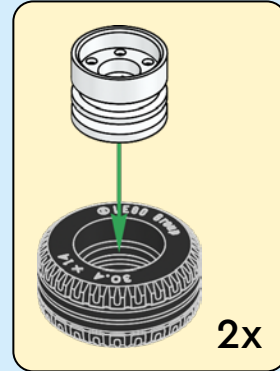

28

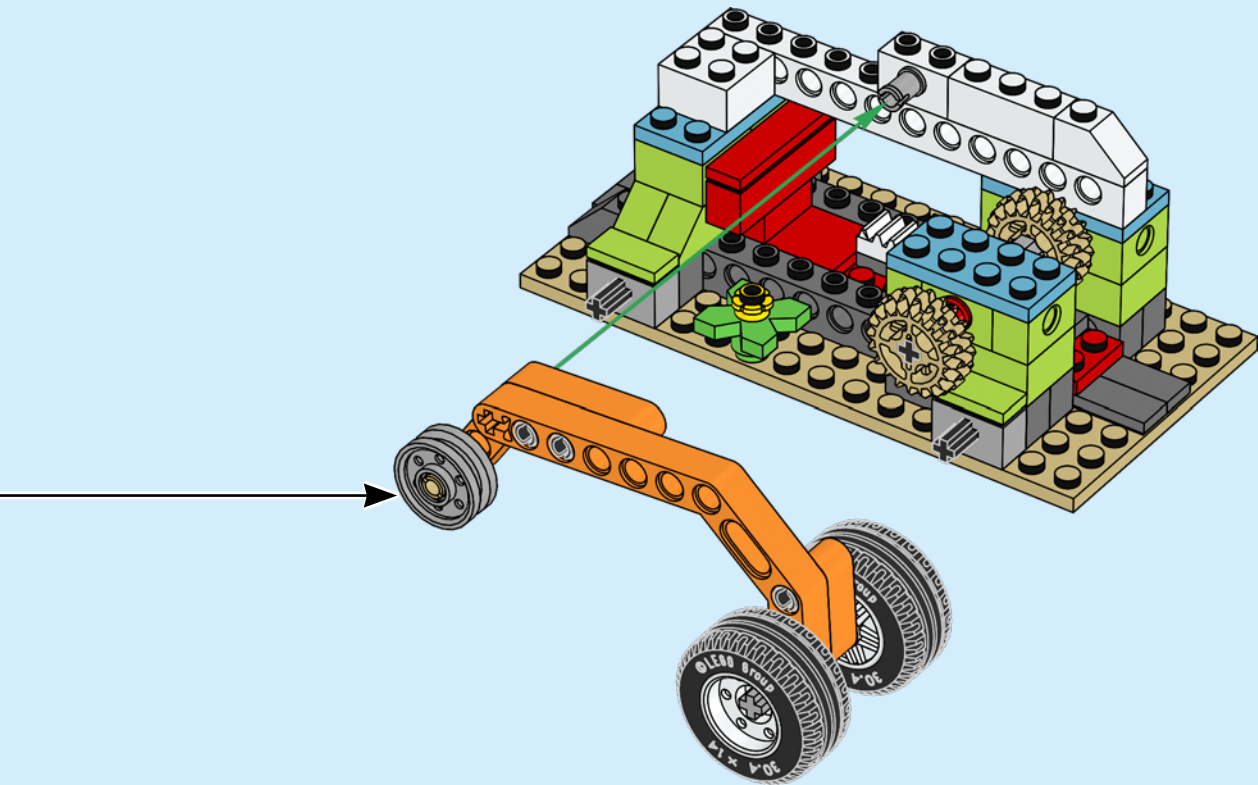

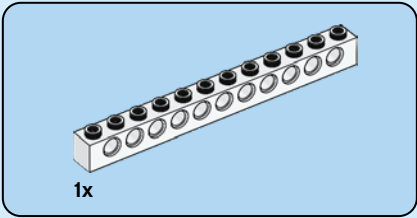

29

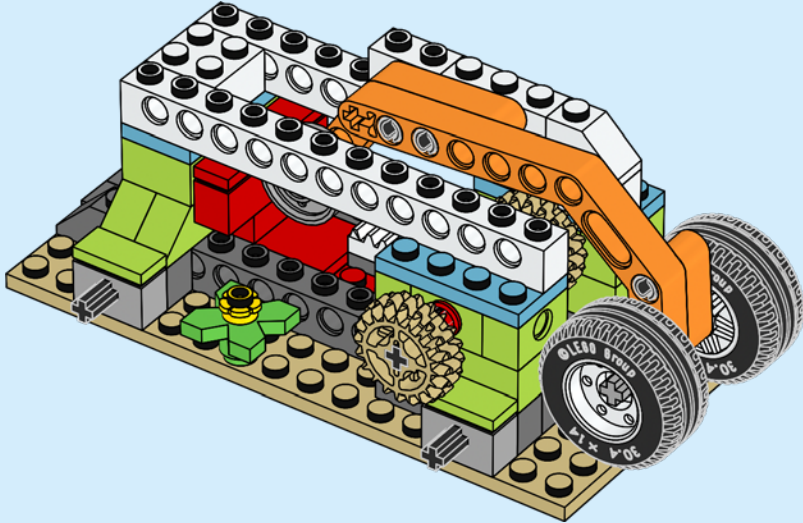

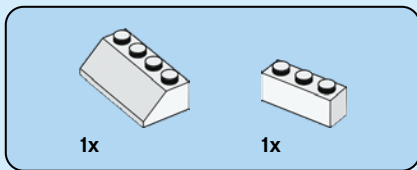

30

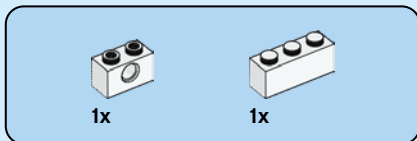
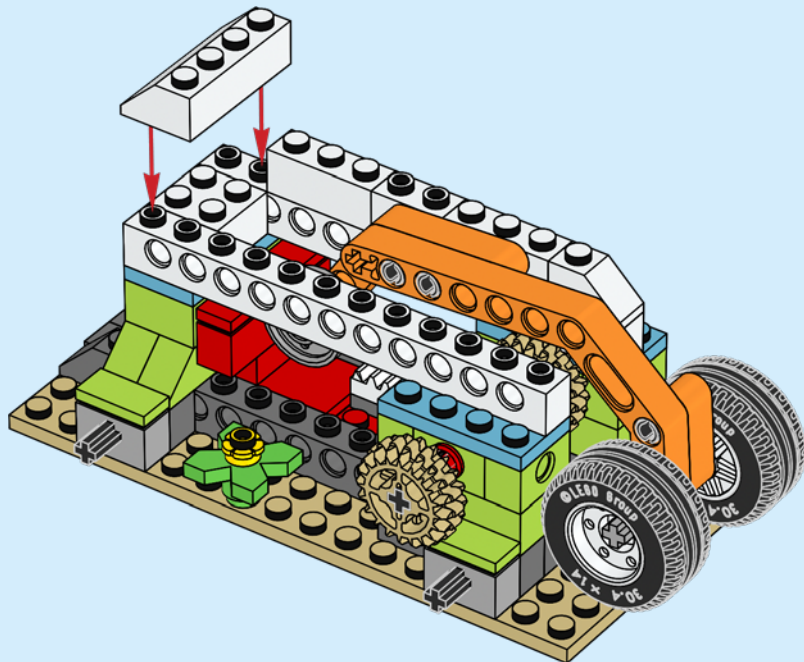

31

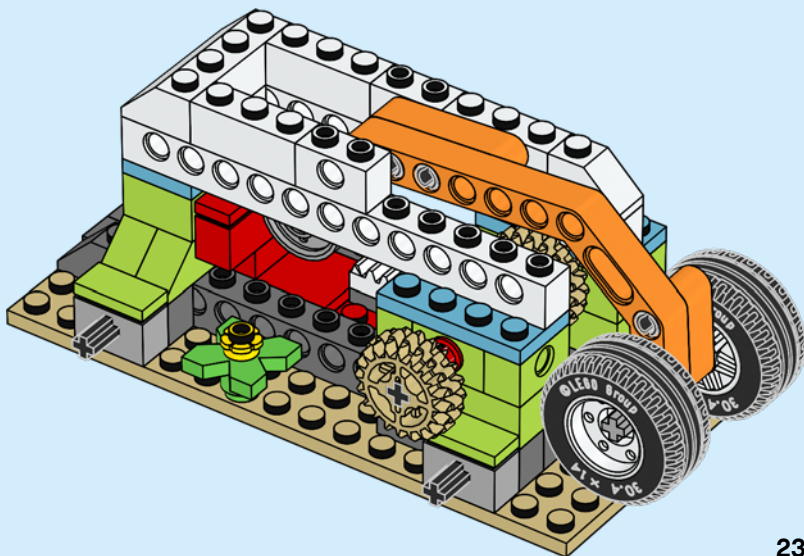



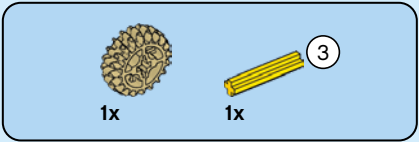

32

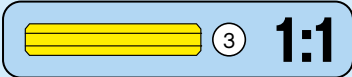
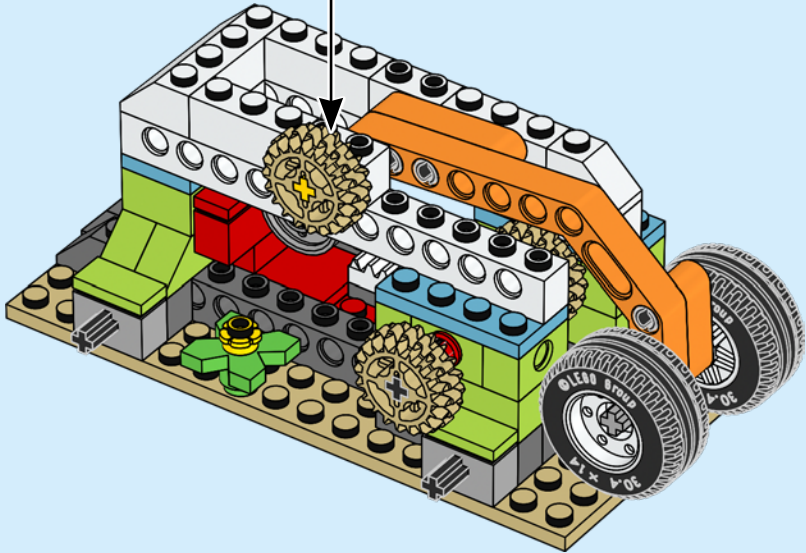
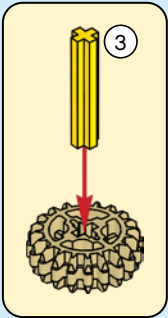



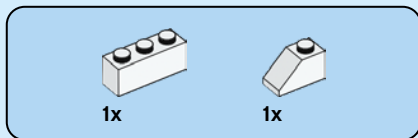

33

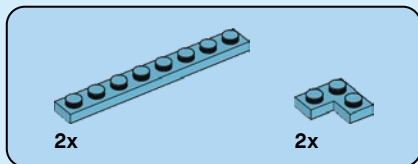
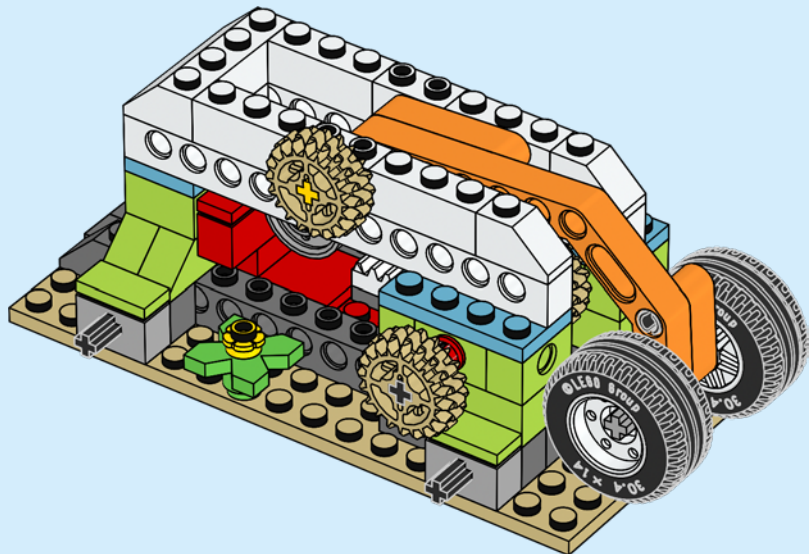

34

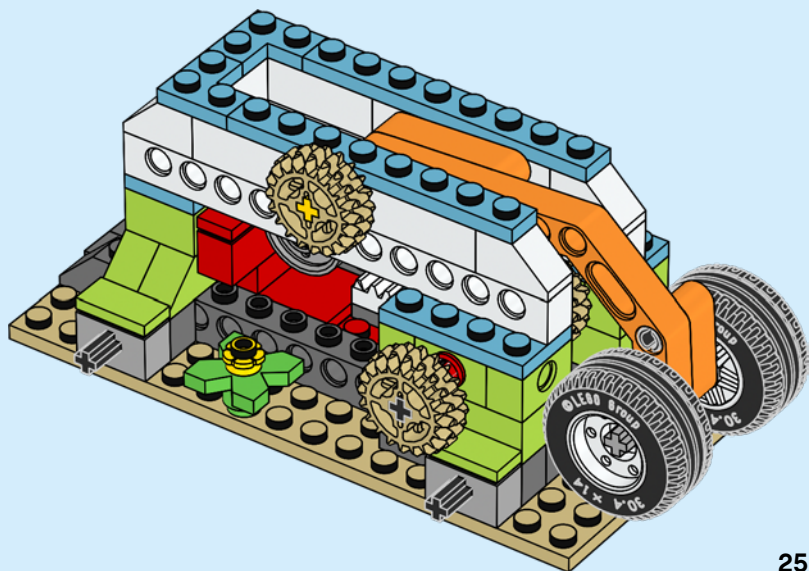

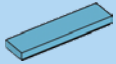

1x

35

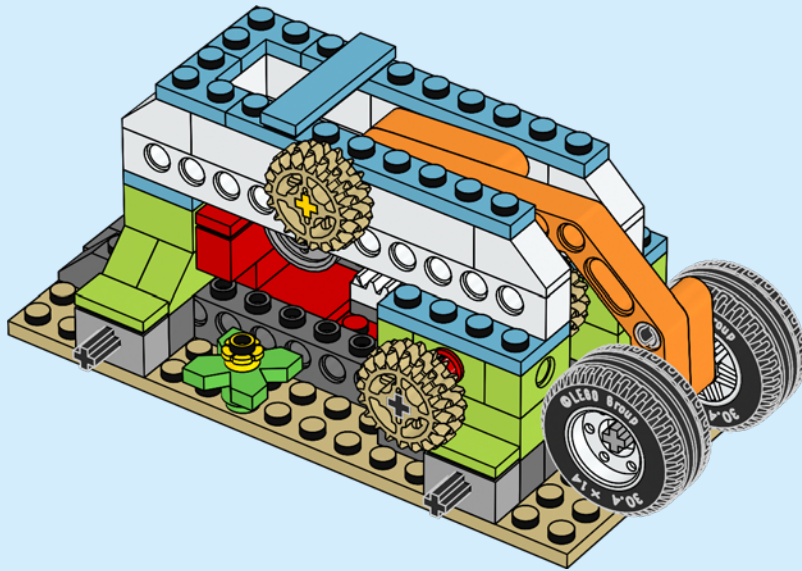

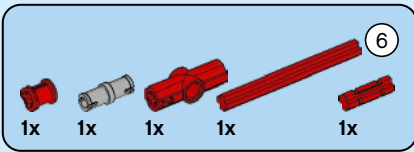

36

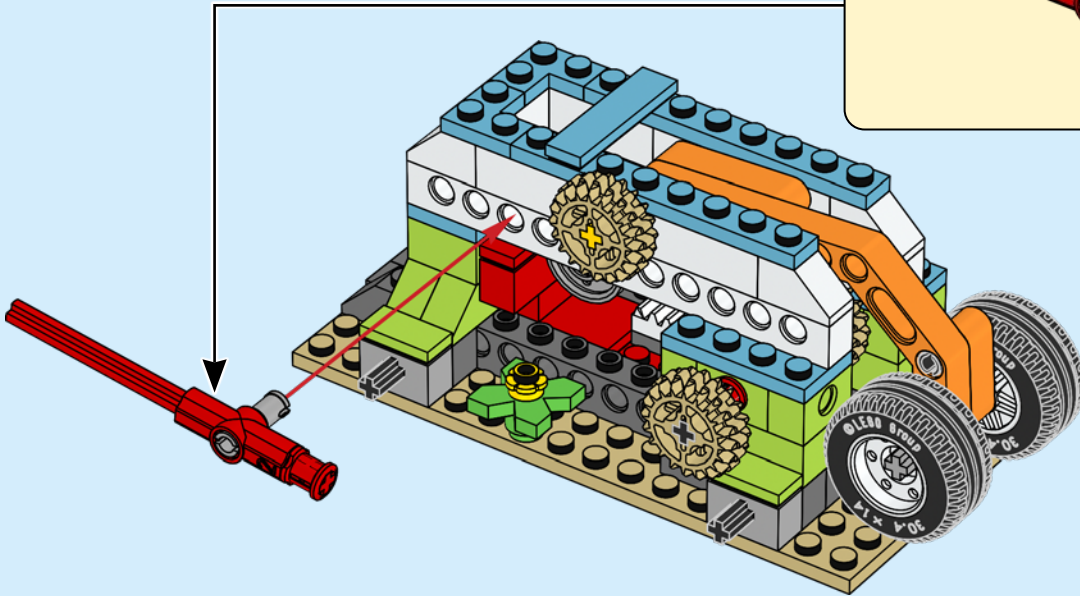
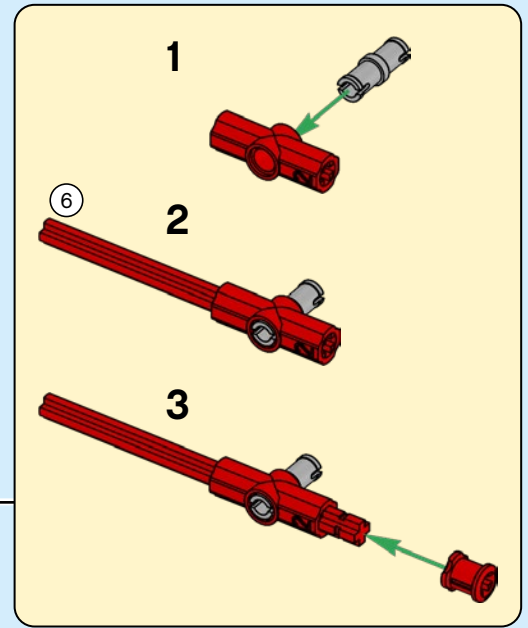

LEGO and the LEGO logo are trademarks of the LEGO Group. ©2022 The LEGO Group. 6424372

*FIRST*® is a registered trademark of For Inspiration and Recognition of Science and Technology (*FIRST*). LEGO® is a registered trademark of the LEGO Group. *FIRST*® LEGO® League and SUPERPOWERED™ are jointly held trademarks of *FIRST* and the LEGO Group.

©2022 *FIRST* and the LEGO Group. All rights reserved.