

45823

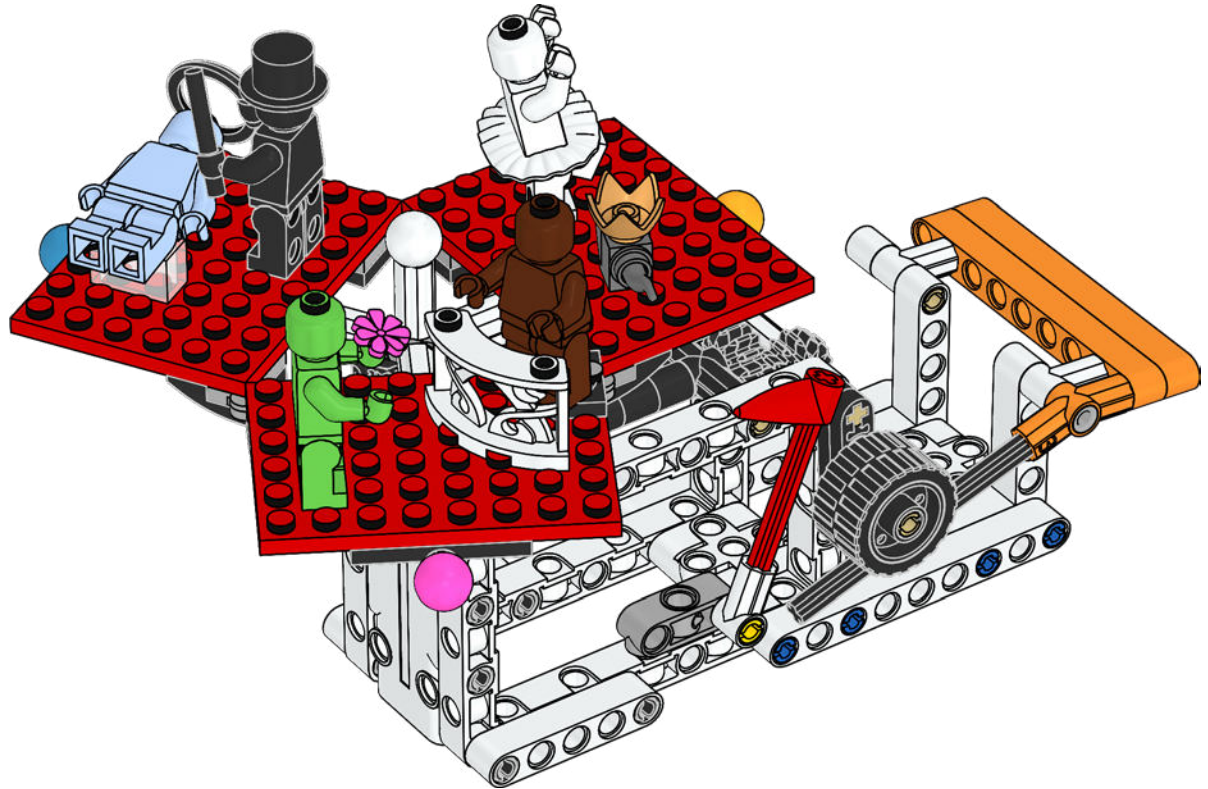

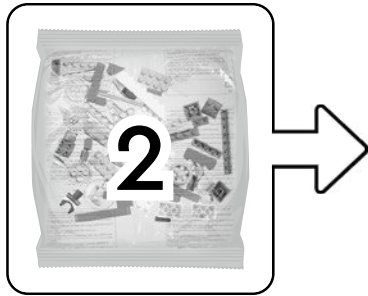

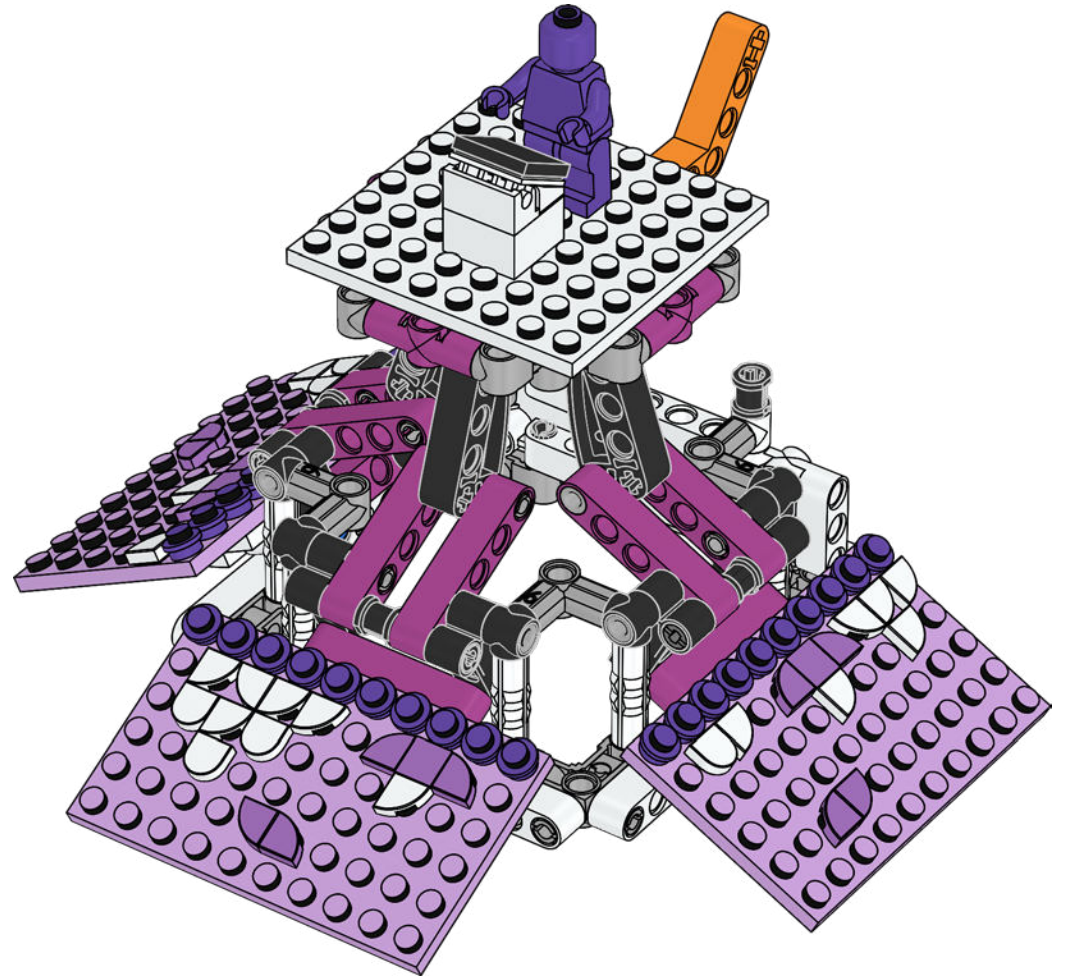

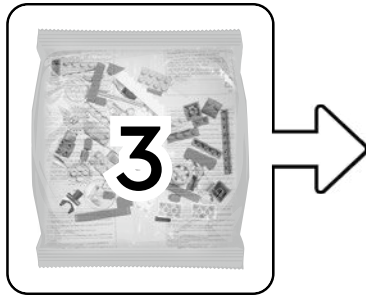
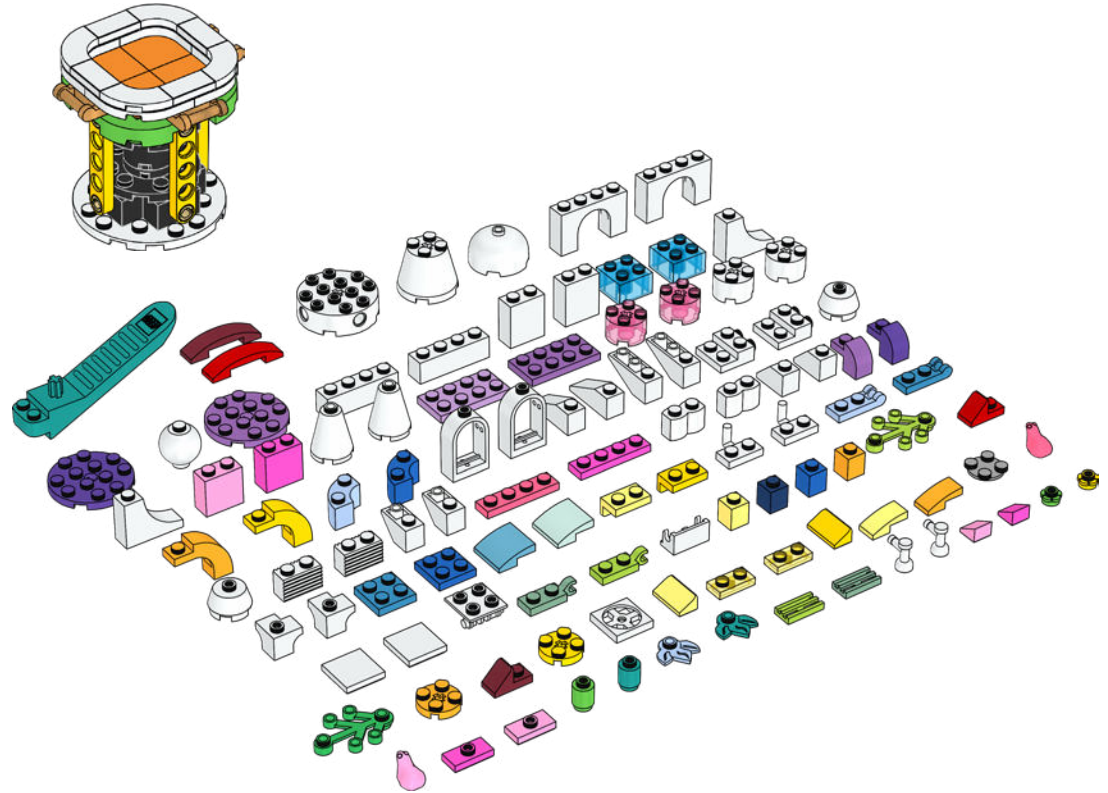
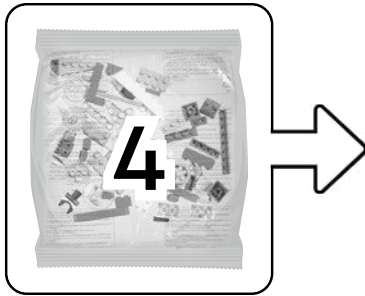
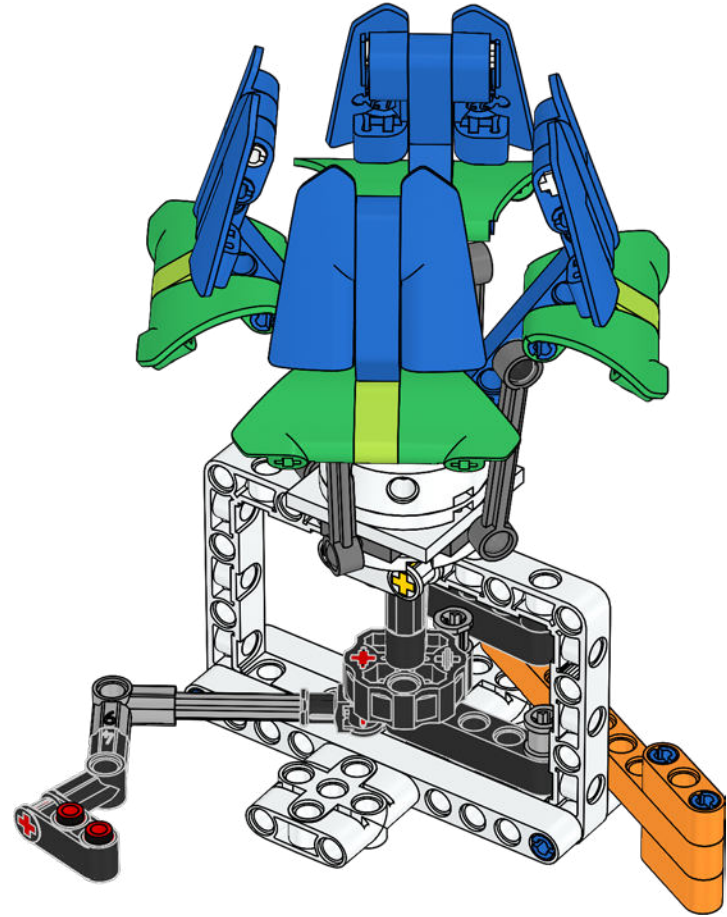
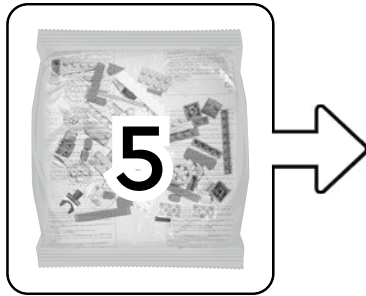

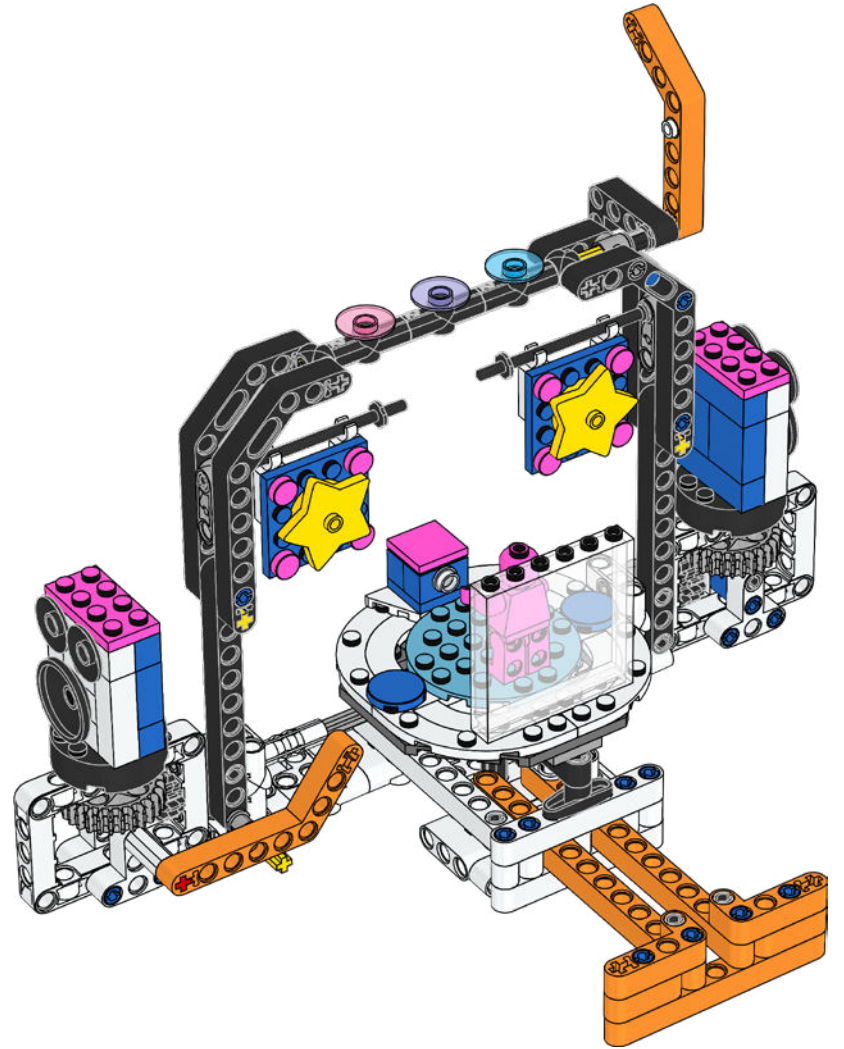
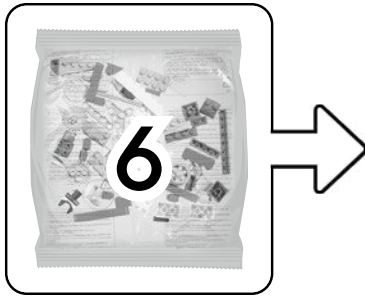

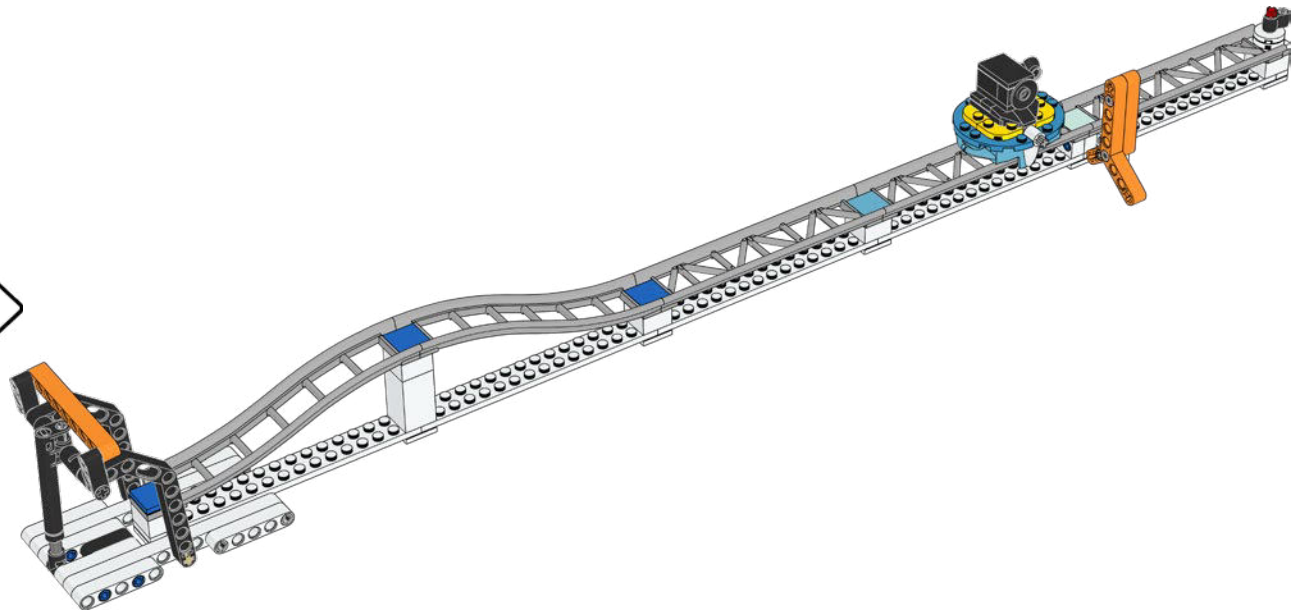
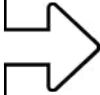

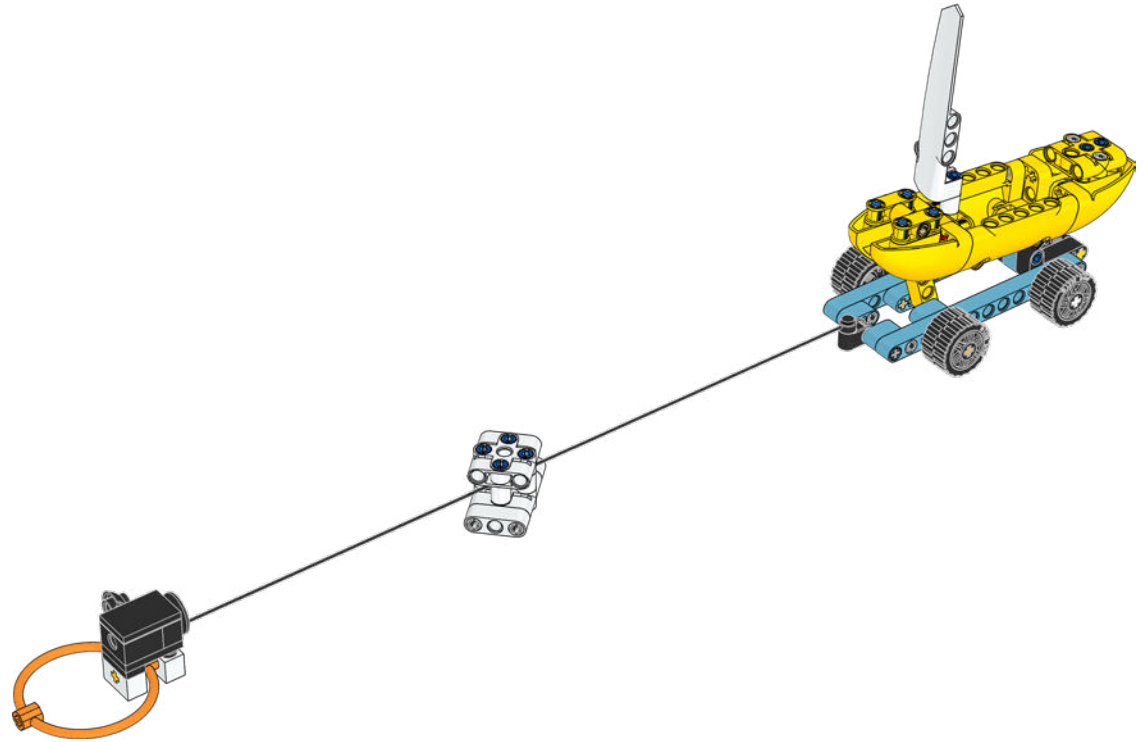
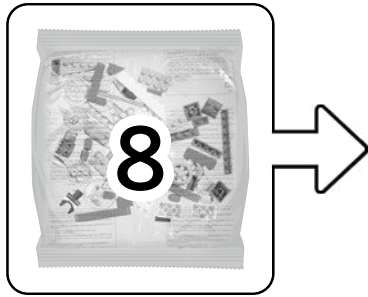



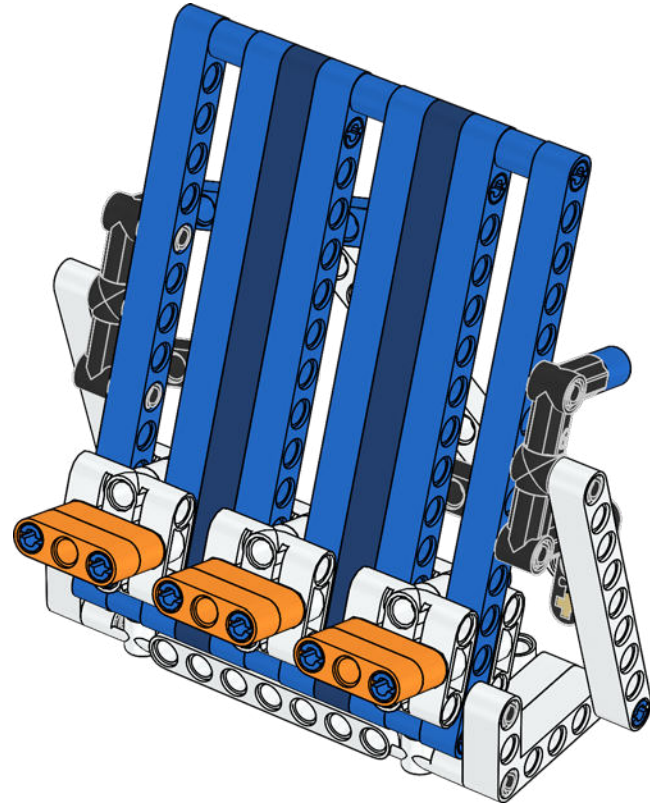
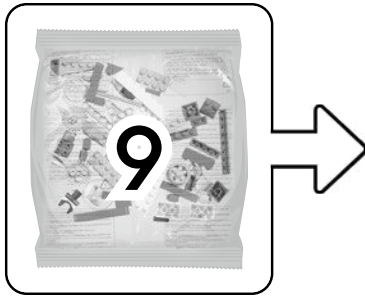

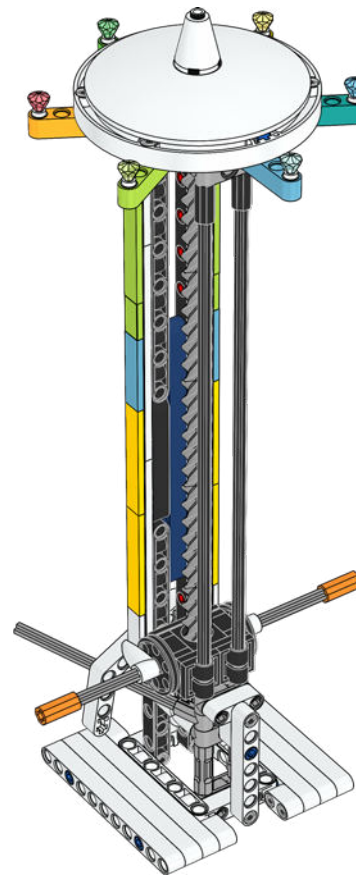
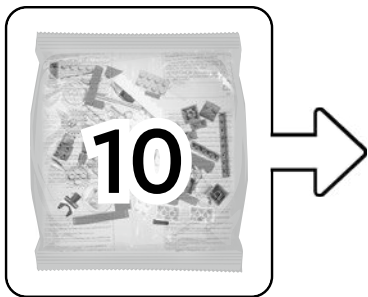

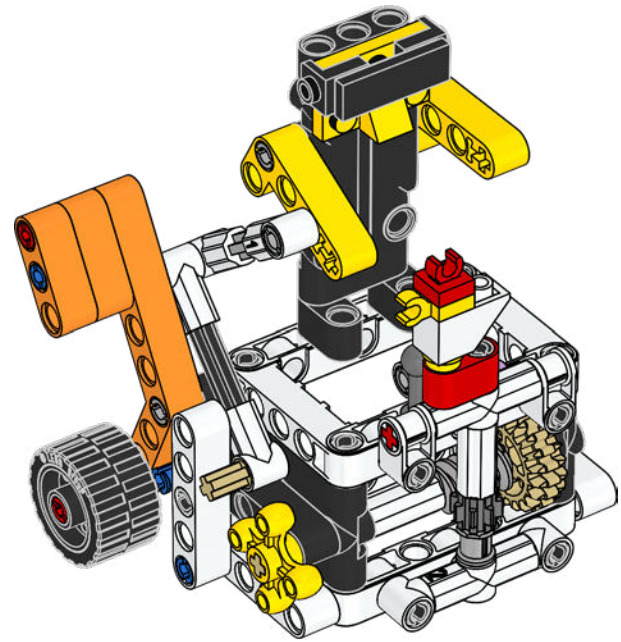
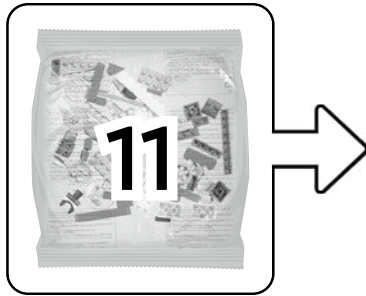

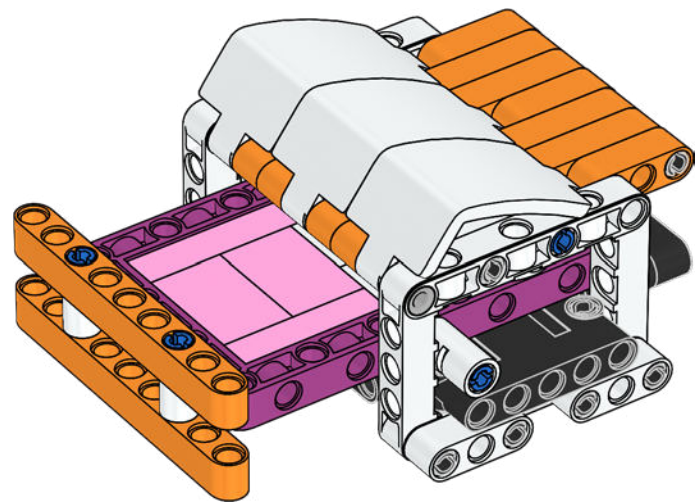
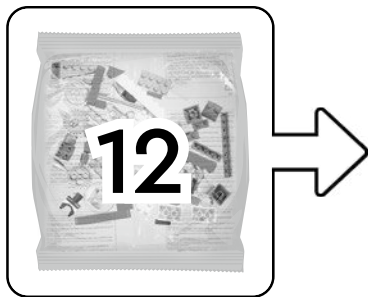

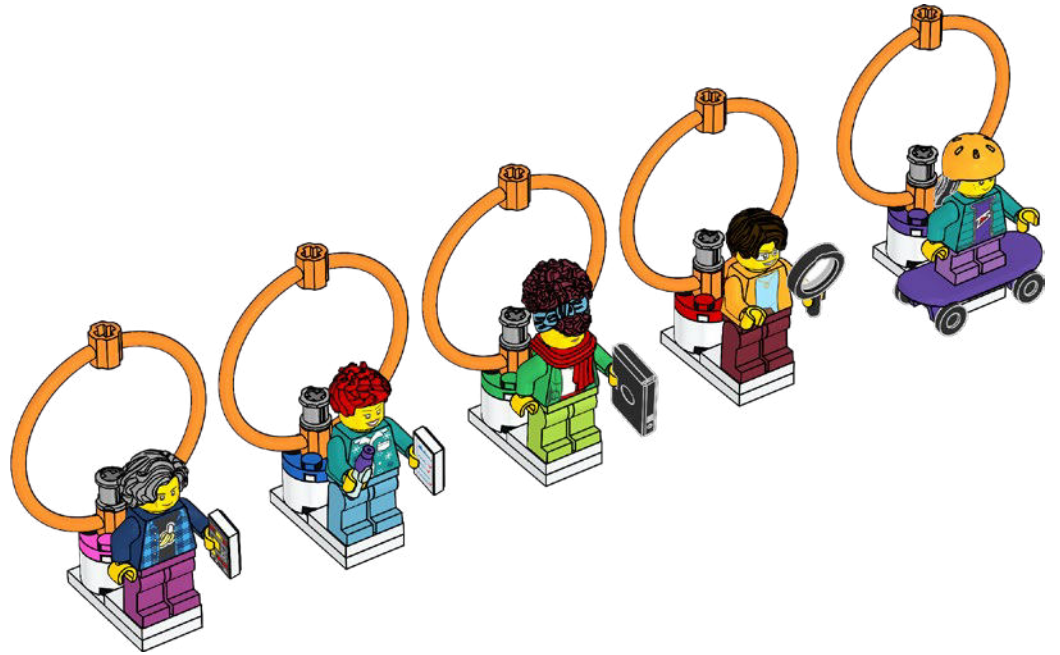
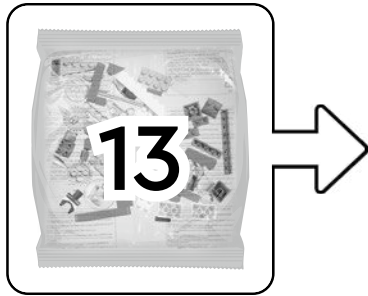

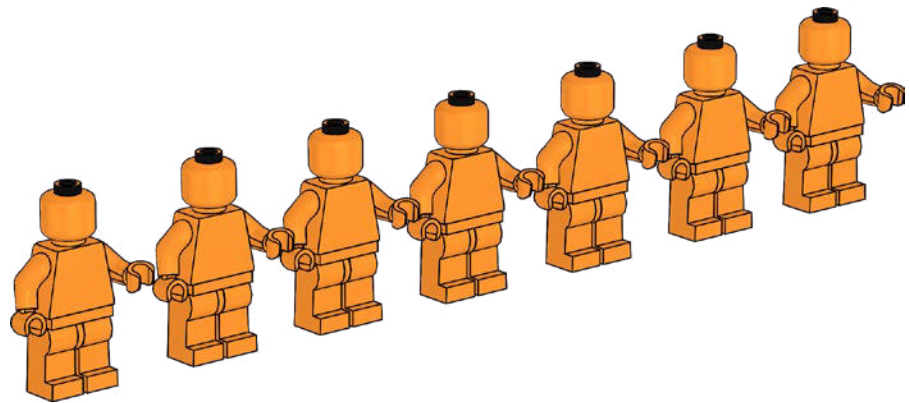
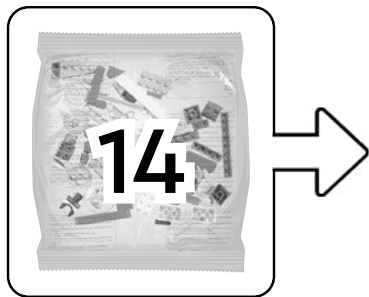

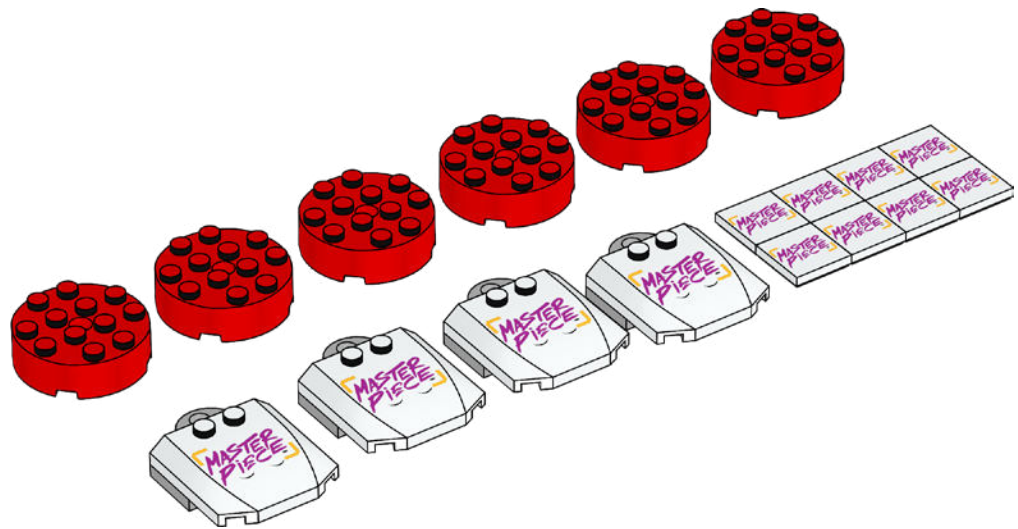
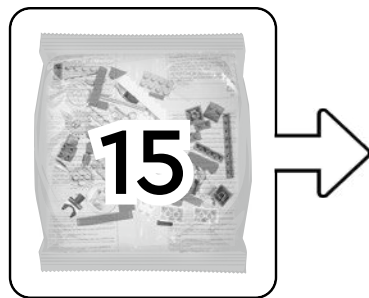

LEGO and the LEGO logo are trademarks of the/sont des marques de commerce du/son marcas registradas de LEGO Group.  
©2023 The LEGO Group.

FIRST™ is a registered trademark of For Inspiration and Recognition of Science and Technology (FIRST). LEGO® is a registered trademark of the LEGO Group. FIRST™ LEGO® League and MASTERPIECE™ are jointly held trademarks of FIRST and the LEGO Group.  
©2023 FIRST and the LEGO Group. All rights reserved.