

45823

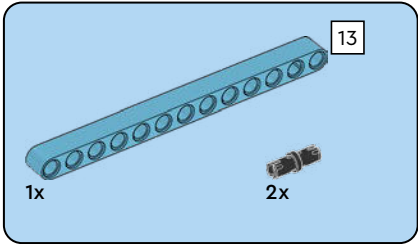

1

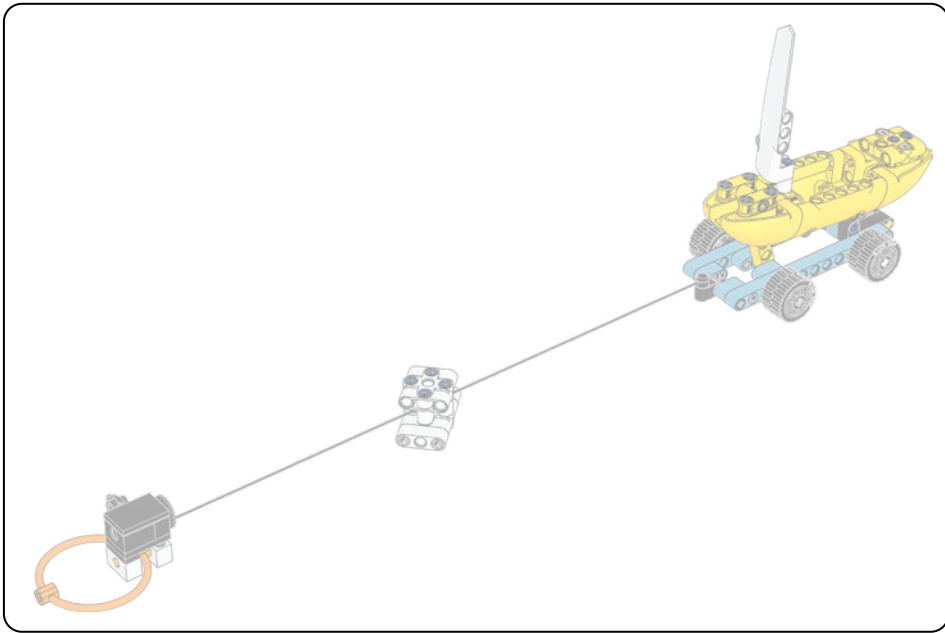
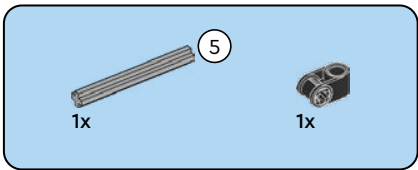
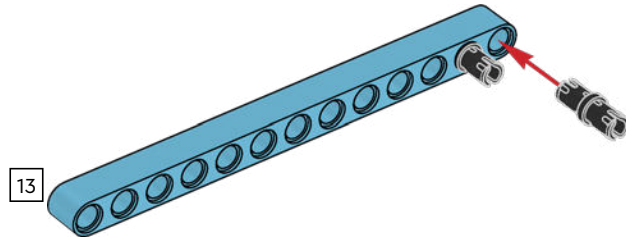

2

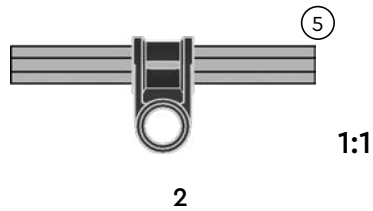

1x

3

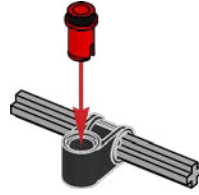

2x

2x

4

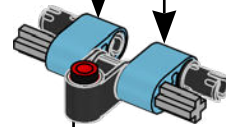
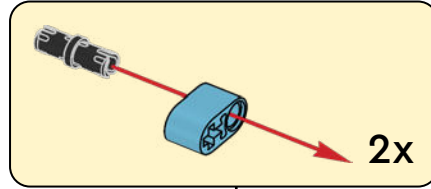

5

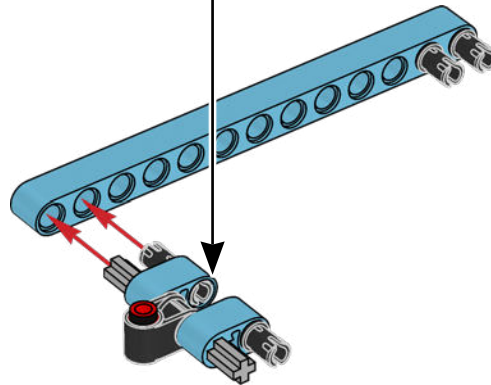

3



6

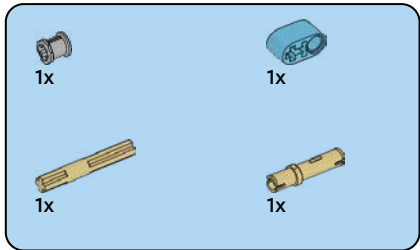
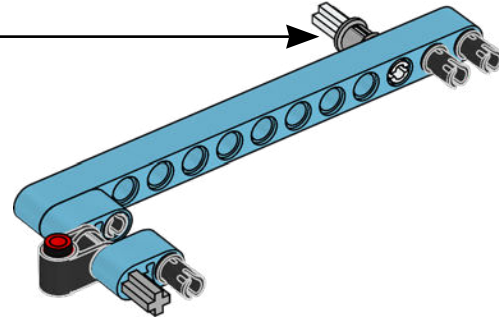
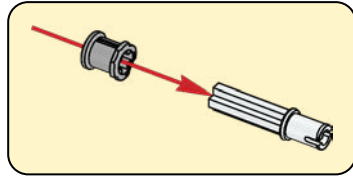

7

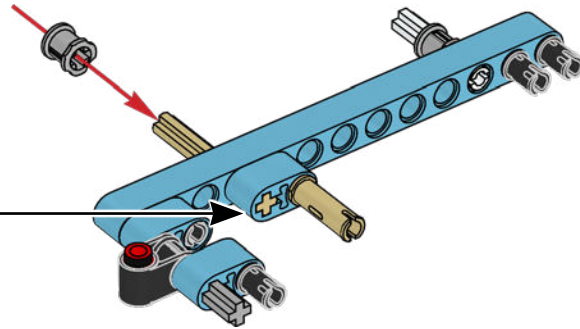
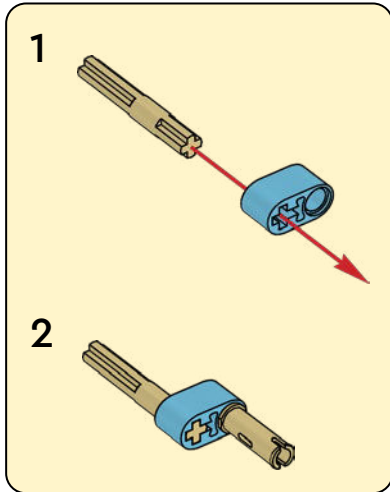

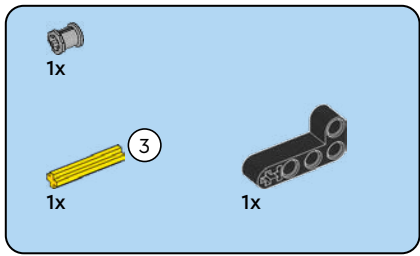

8

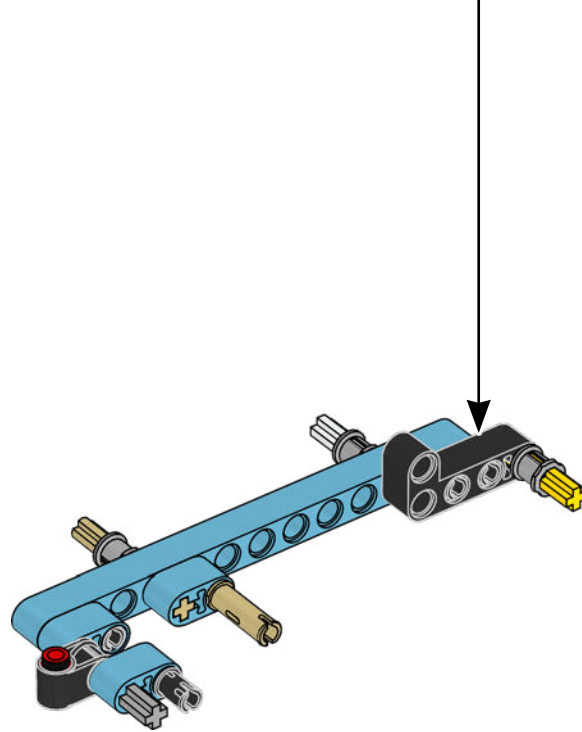
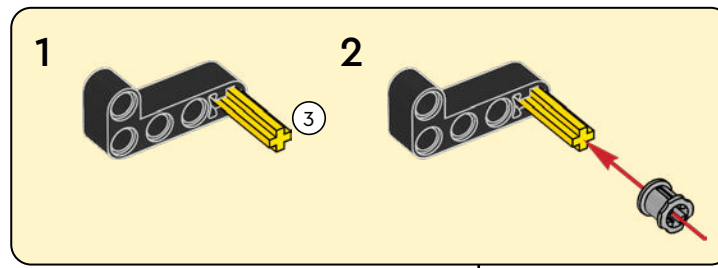

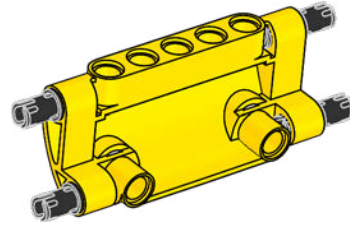
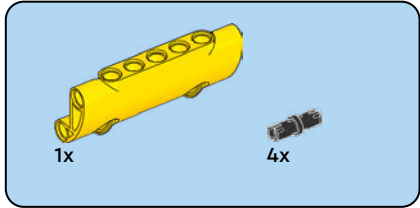
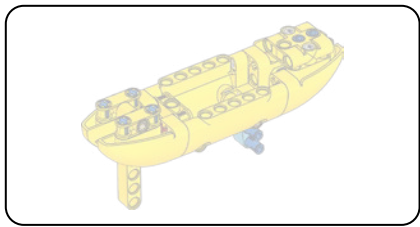

9

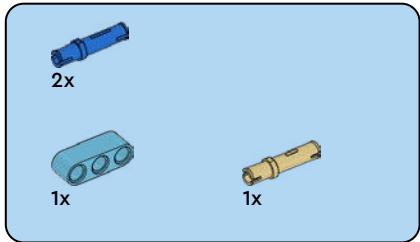

10

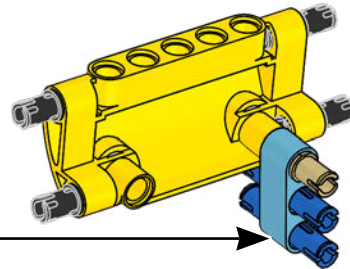
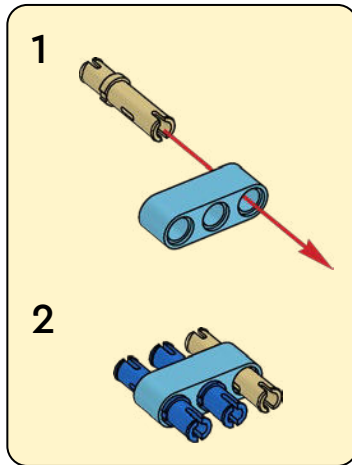

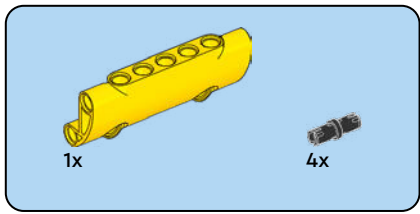

11

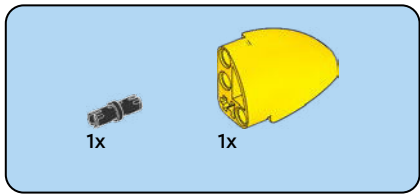
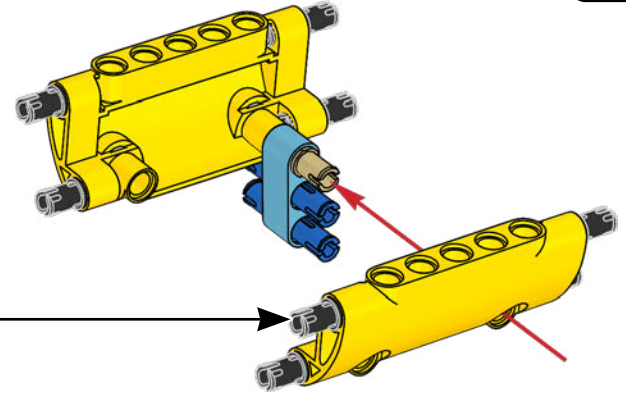
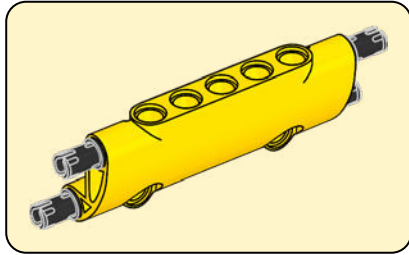

12

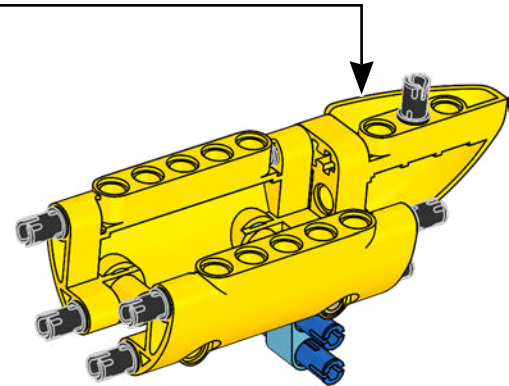
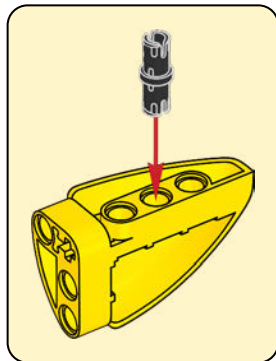

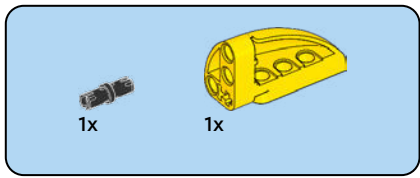

13

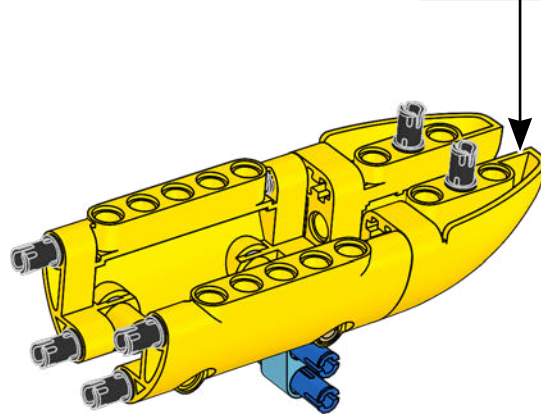
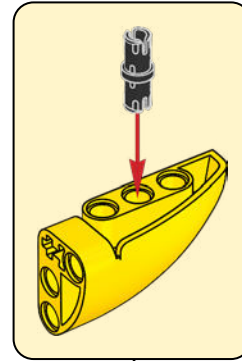

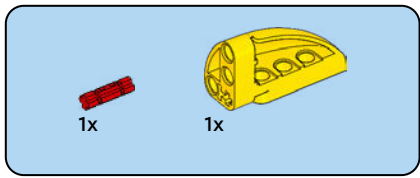

14

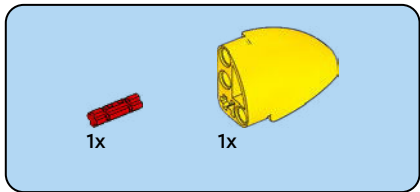
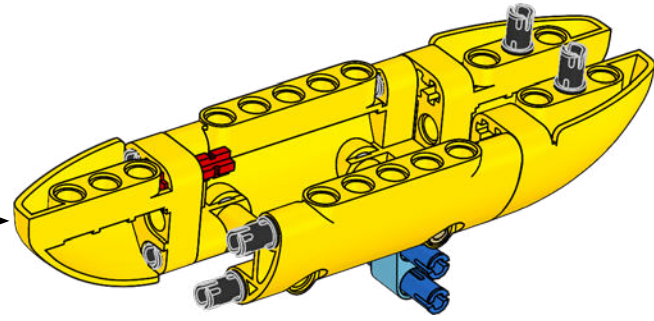
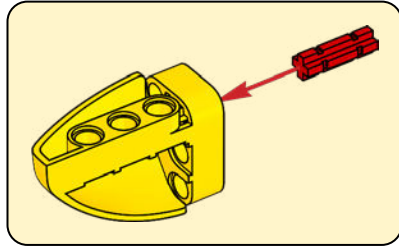

15

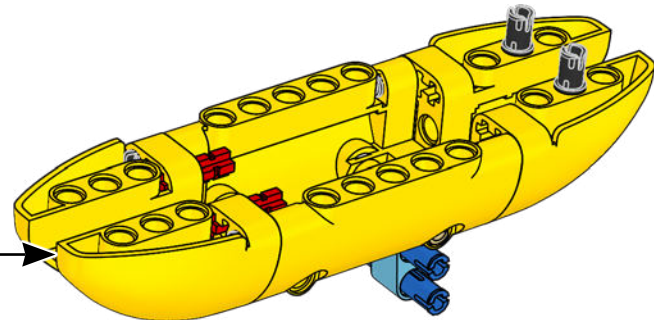
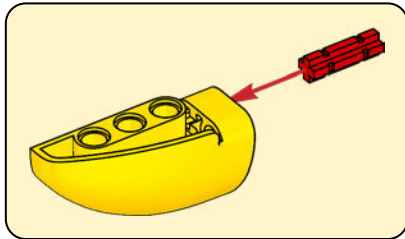

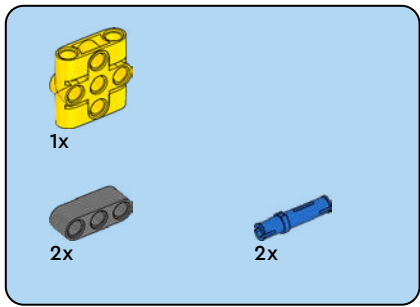

16

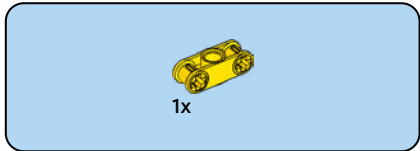
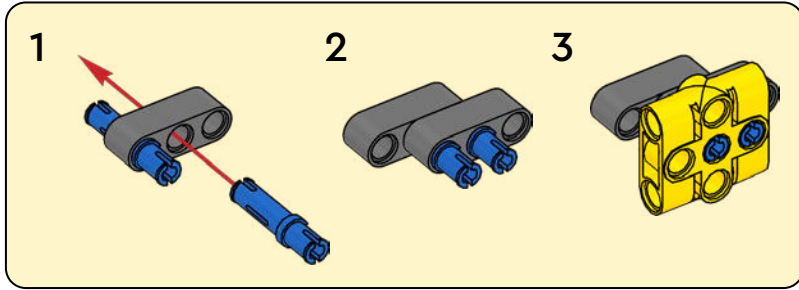

17

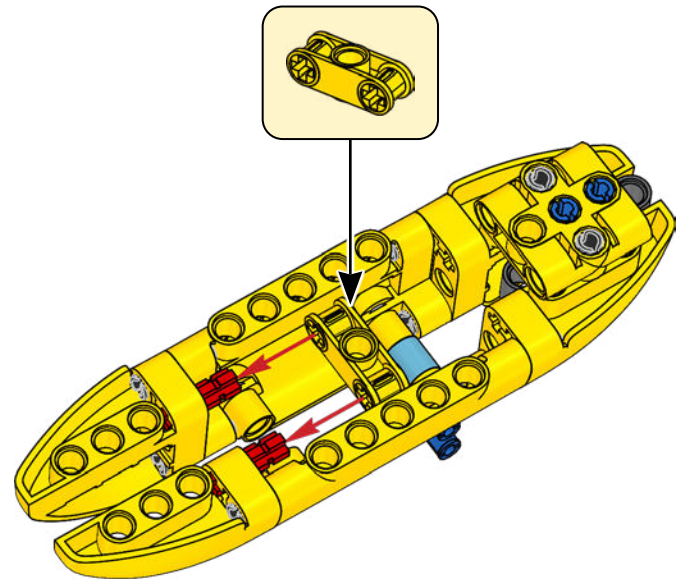
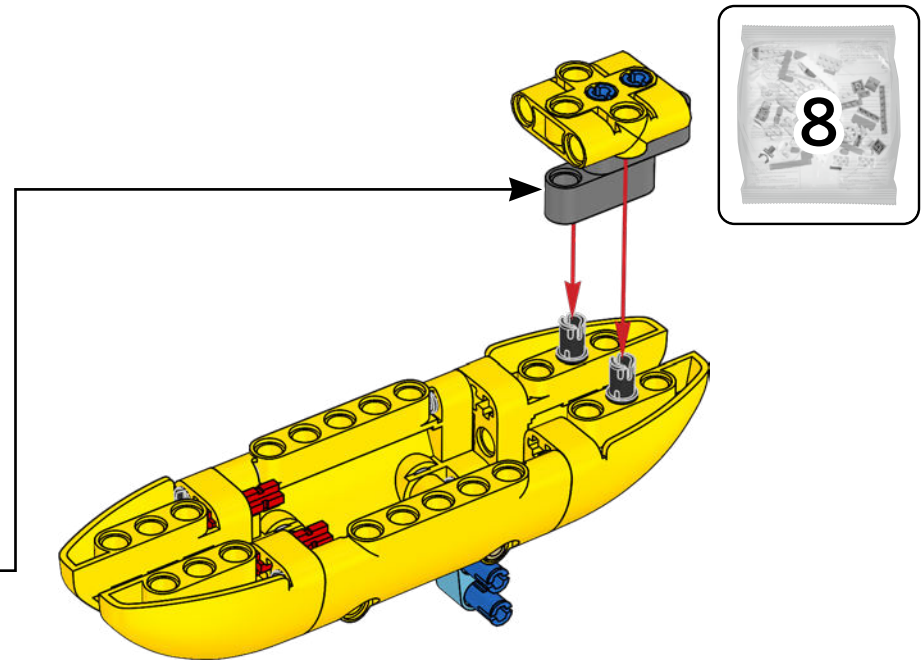

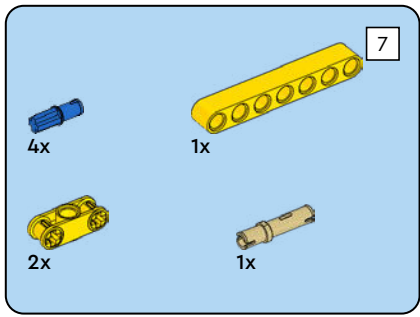

18

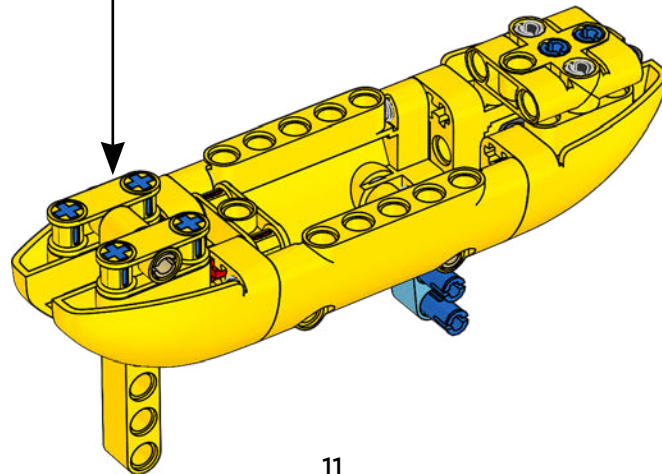
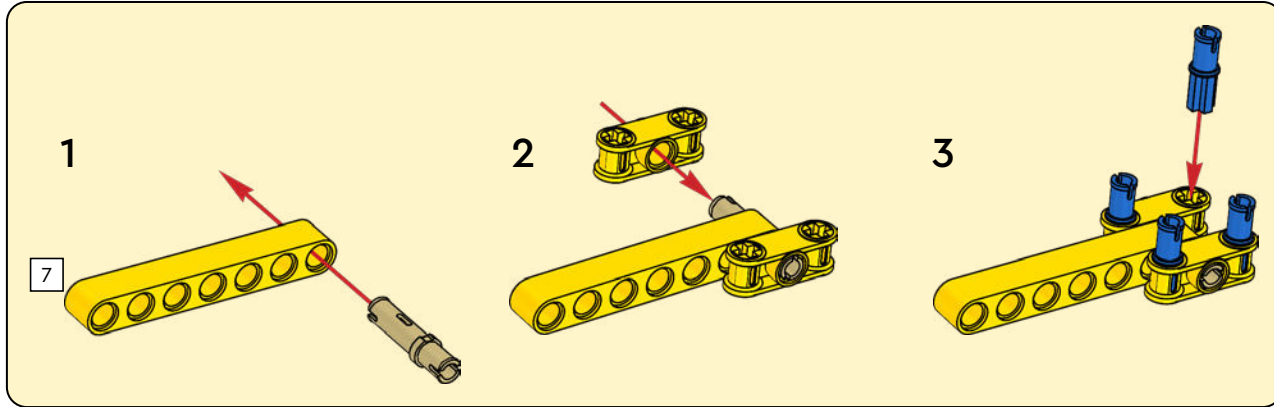

19

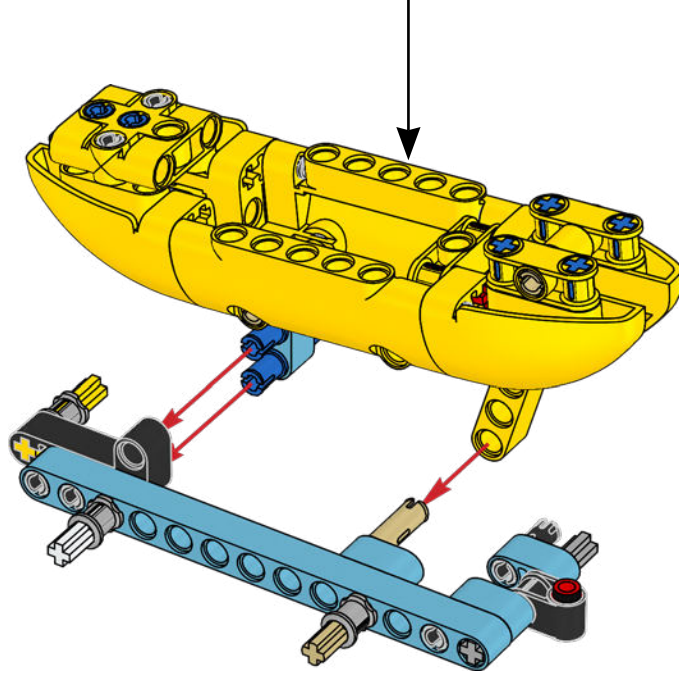

8

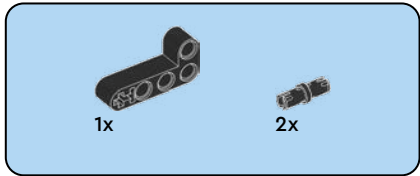

20

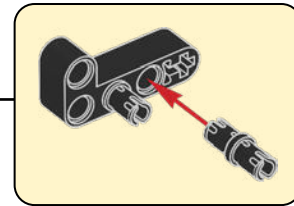
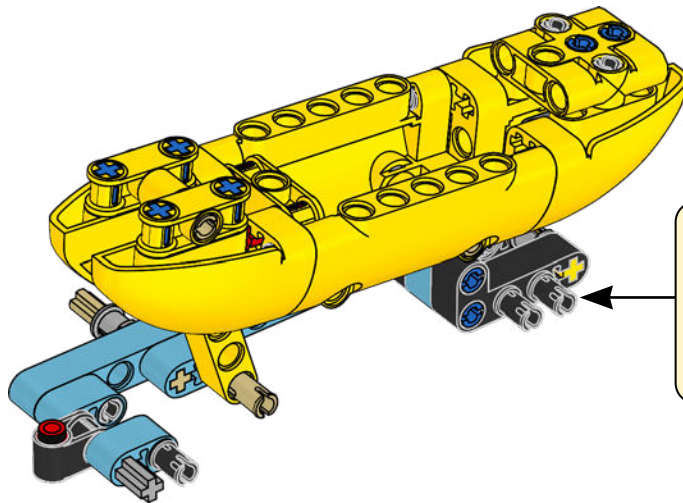

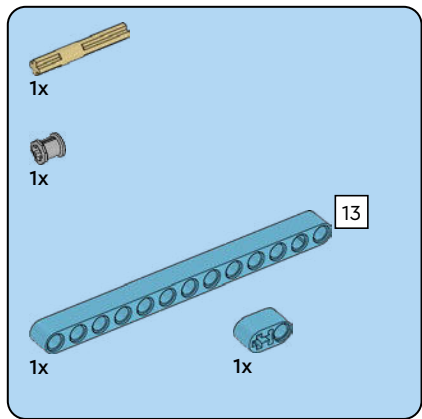

21

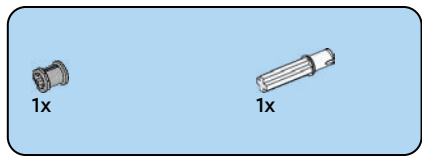
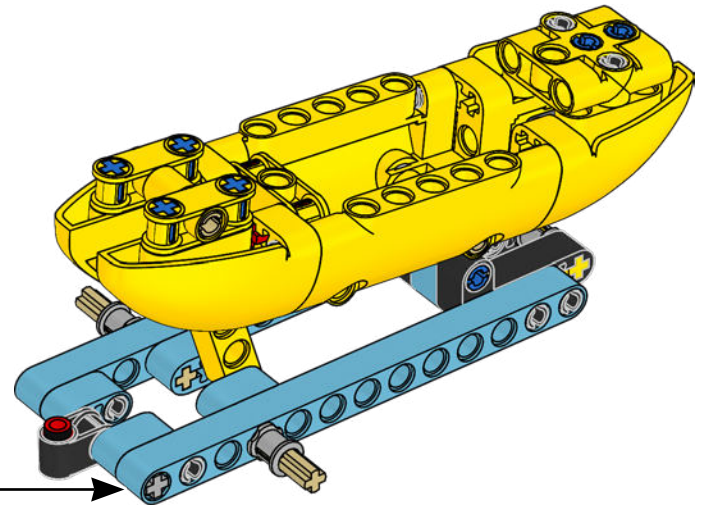
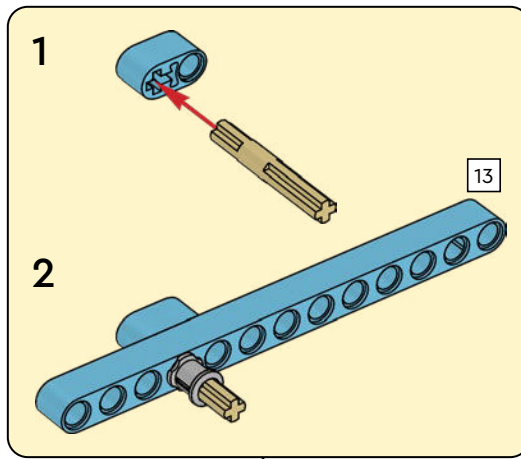

22

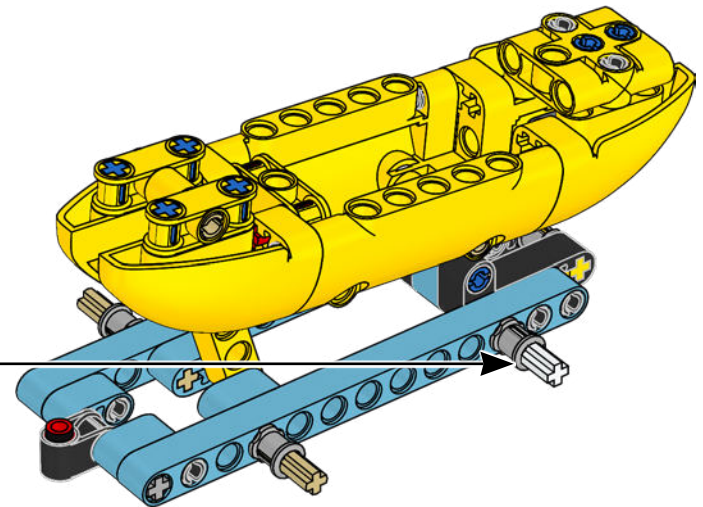
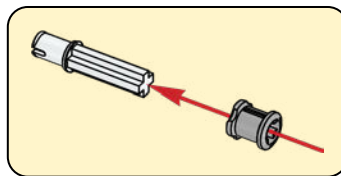

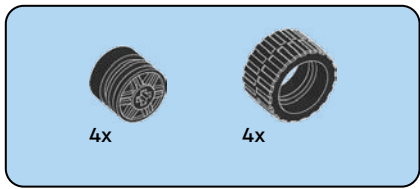

23

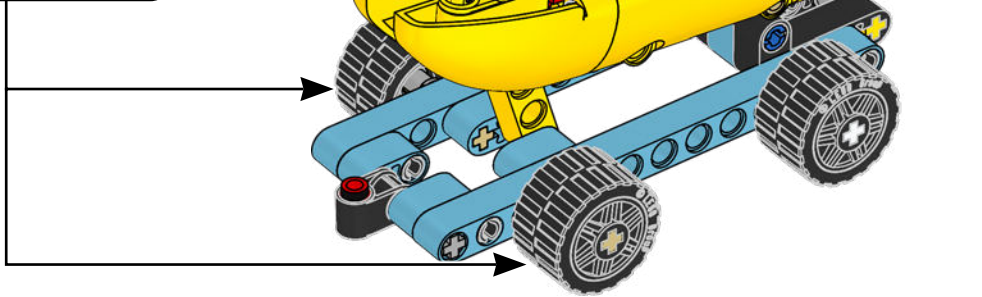
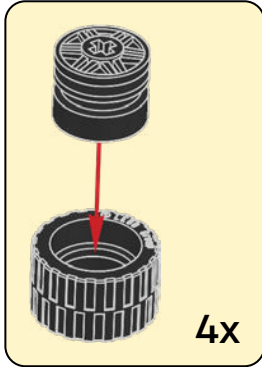

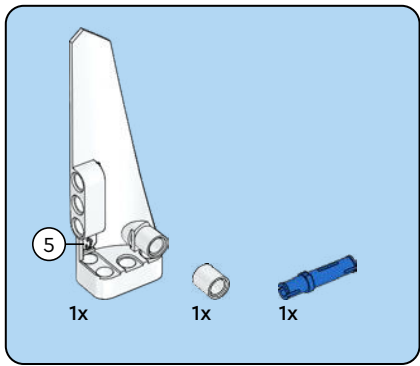

24

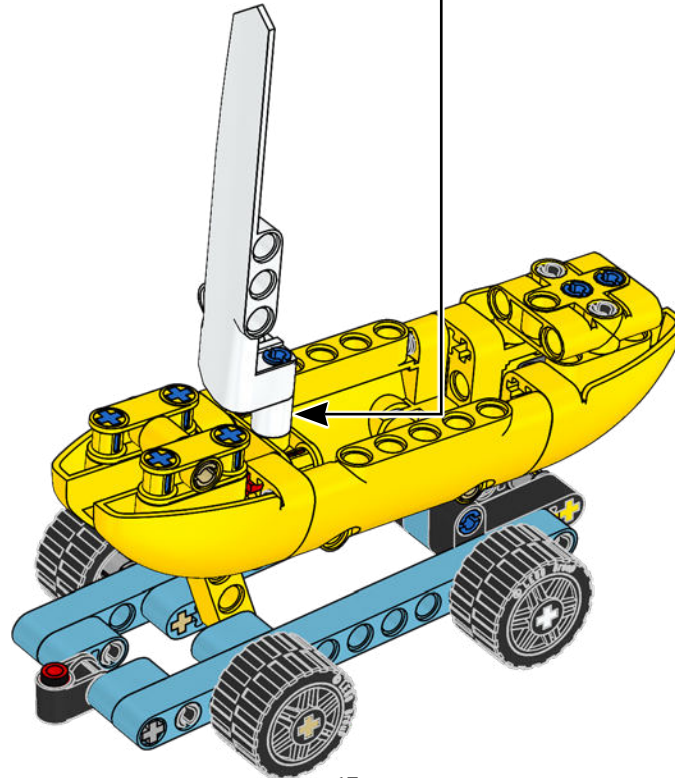
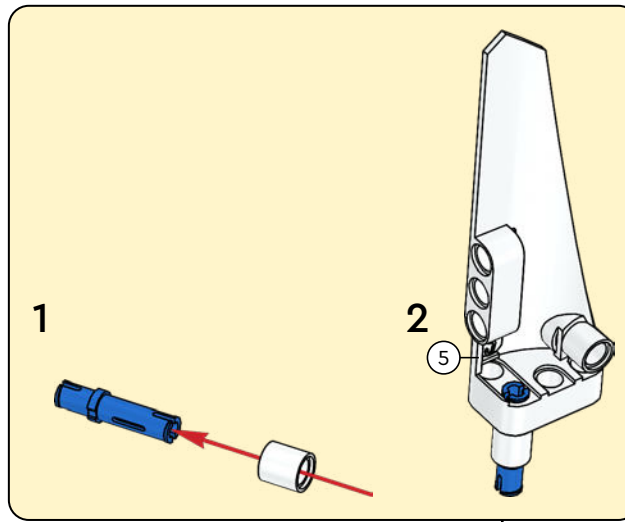

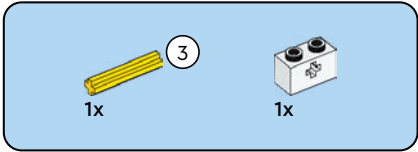
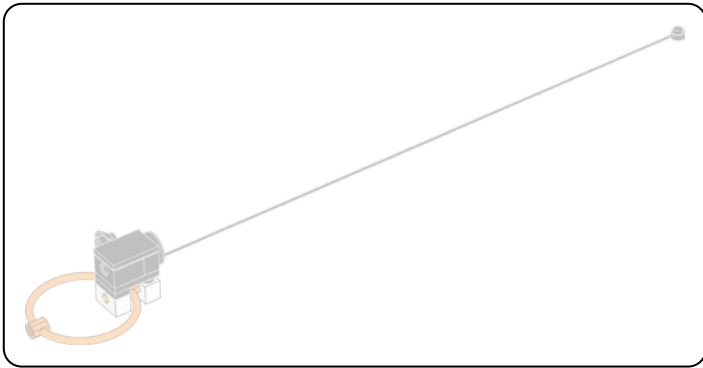

25

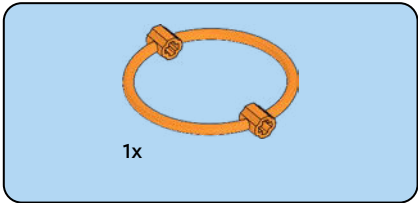
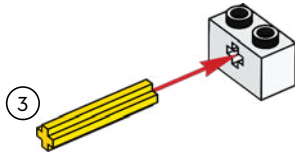

26

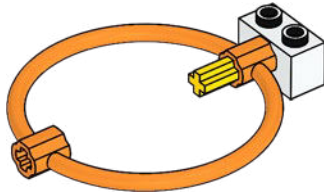



1x

27

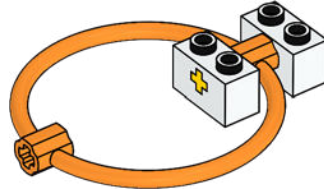

1x



1x



1x

28

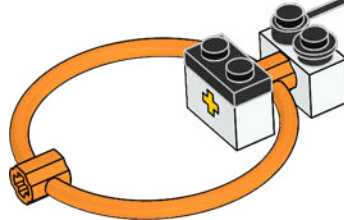

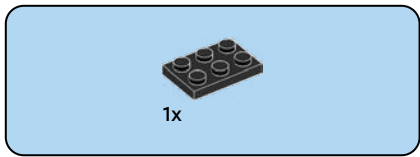

29

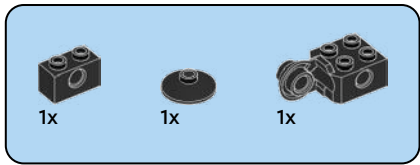
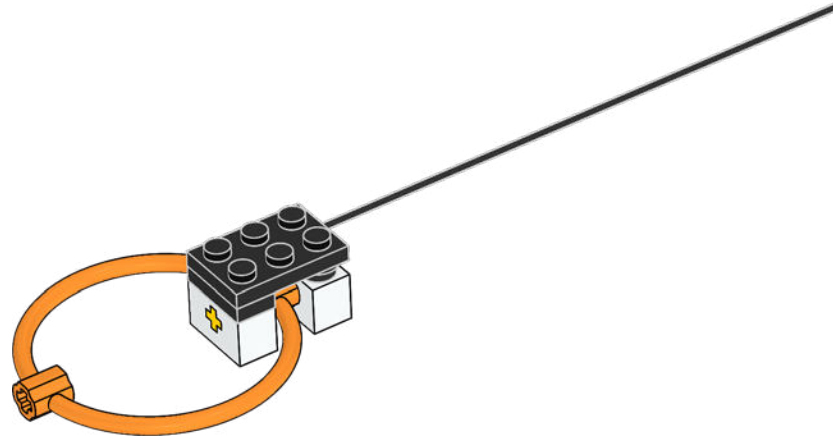

30

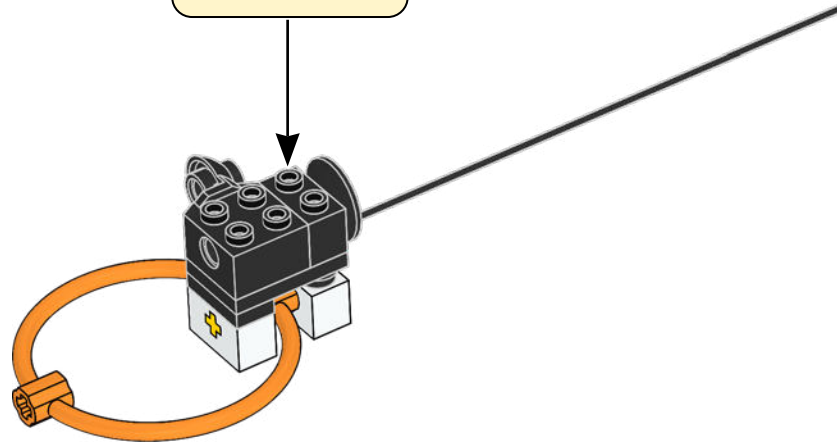
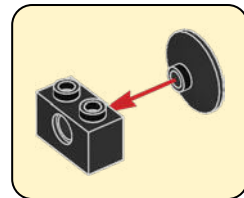

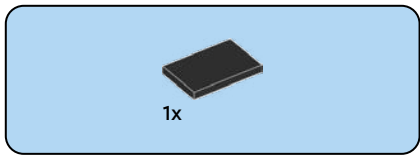

31

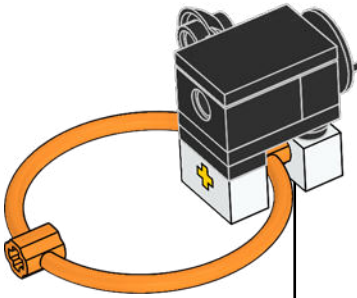

32

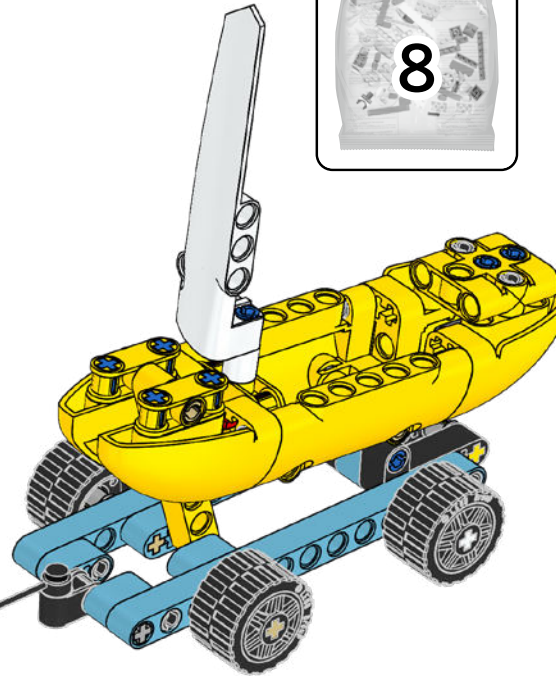
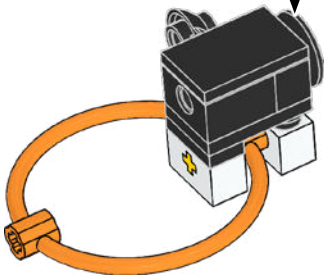

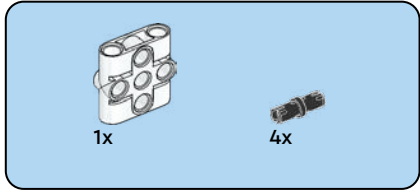
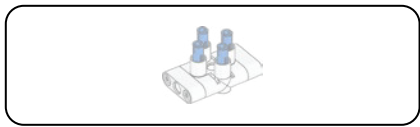

33

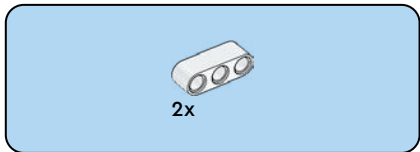

34

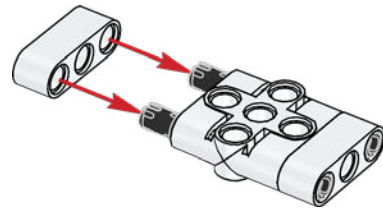

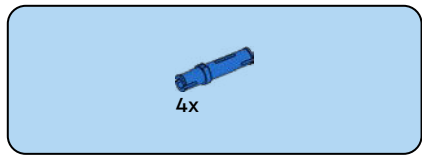

35

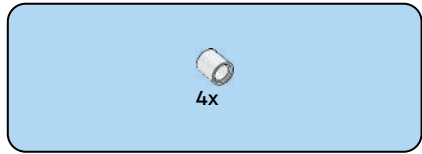
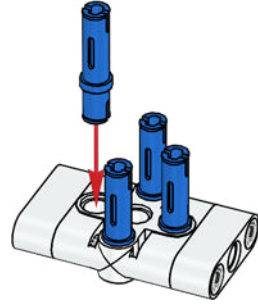

36

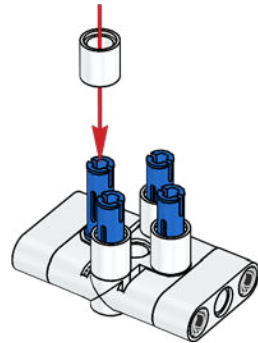

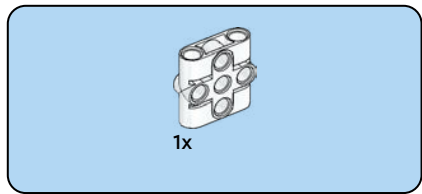

37

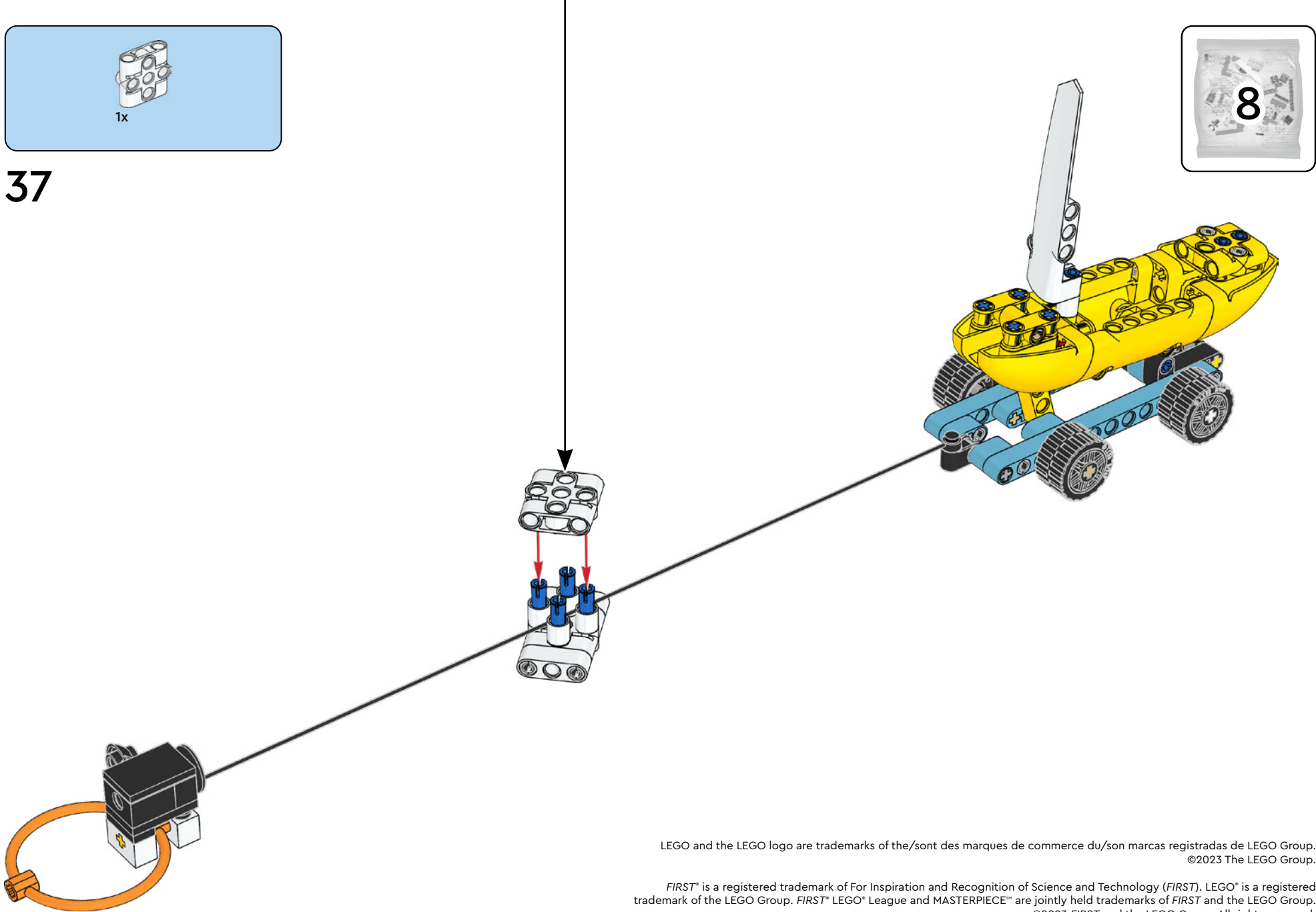

LEGO and the LEGO logo are trademarks of the/son des marques de commerce du/son marcas registradas de LEGO Group.
©2023 The LEGO Group.

FIRST® is a registered trademark of For Inspiration and Recognition of Science and Technology (FIRST). LEGO® is a registered trademark of the LEGO Group. FIRST® LEGO® League and MASTERPIECE™ are jointly held trademarks of FIRST and the LEGO Group.
©2023 FIRST and the LEGO Group. All rights reserved.